

PSTricks

pst-circ

A PSTricks package for drawing electric circuits; v.2.12a

October 9, 2014

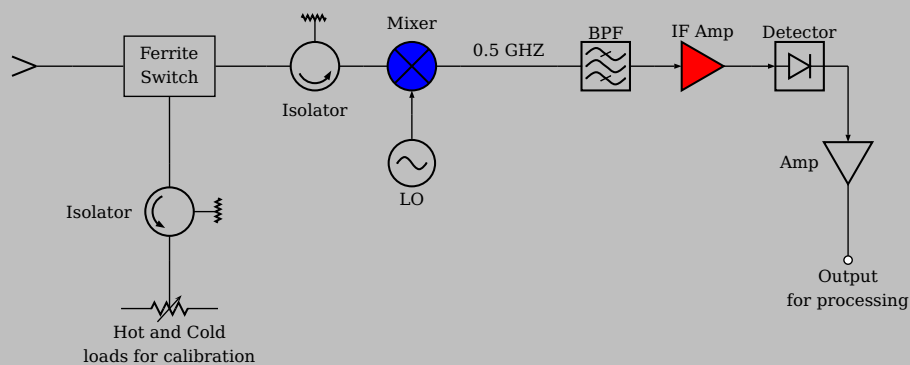

Package author(s):
Herbert Voß

Contents

1	The basic system	4
1.1	Parameters	4
1.2	Macros	4
1.3	Parameters	13
1.4	Special objects	23
2	Modified default symbols	24
2.1	Dipole	24
3	Examples	26
4	Microwave symbols	35
4.1	New monopole components	35
4.2	New monopole macro-components	36
4.3	New dipole macro-components	36
4.4	New tripole macro-components	39
4.5	New quadripole macro-components	41
4.6	Examples	42
5	Flip Flops - logical elements	45
5.1	The Options	45
5.2	Basic Logical Circuits	45
5.3	RS Flip Flop	50
5.4	D Flip Flop	51
5.5	JK Flip Flop	51
5.6	Other Options	51
5.7	The Node Names	52
5.8	Examples	53
6	Logical circuits in american style	55
6.1	Examples	57
7	Relay Ladder Logic	76
7.1	Examples	78
8	Adding new components	79
9	List of all optional arguments for pst-circ	81
	References	91

The package `pst-circ` is a collection of graphical elements based on `PStricks` that can be used to facilitate display of electronic circuit elements. For example, an equivalent circuit of a voltage source, its source impedance, and a connected load can easily be constructed along with arrows indicating current flow and potential differences. The emphasis is upon the circuit elements and the details of the exact placement are hidden as much as possible so the author can focus on the circuitry without the distraction of sorting out the underlying vector graphics.

`pst-circ` loads by default the following packages: `pst-node`, `multido`, `pst-xkey`, and, of course `pstricks`. All should be already part of your local $\text{T}_{\text{E}}\text{X}$ installation. If not, or in case of having older versions, go to <http://www.CTAN.org/> and load the newest version.

Thanks to:

Rafal Bartczuk, Christoph Bersch, François Boone, Vincent Breton, Jean-Côme Charpentier, Patrick Drechsler, Amit Finkler, Felix Gottwald, Markus Graube, Henning Heinze, Christophe Jorssen, Bernd Landwehr, Michael Lauterbach, Manuel Luque, Steven P. McPherson, Patrice Mégret, Ted Pavlic, Alan Ristow, Uwe Siart, Carlos Marcelo de Oliveira Stein, Pierre Vivegnis, Douglas Waud, Richard Weissnar, and Felix Wienker.

1 The basic system

1.1 Parameters

There are specific parameters defined to change easily the behaviour of the `pst-circ` objects you are drawing. You'll find a list in Section 9 on p. 81.

1.2 Macros

Dipole macros

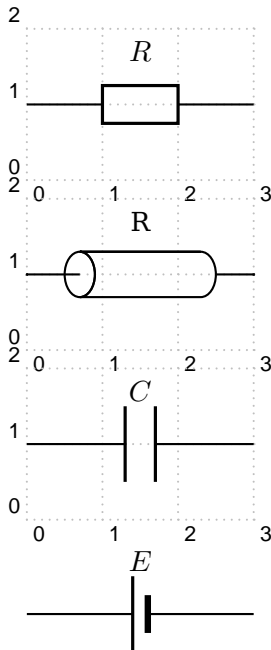

```
\begin{pspicture}[showgrid=true](3,2)
  \pnodes(0,1){A}(3,1){B}
  \resistor(A)(B){R$}
\end{pspicture}
```

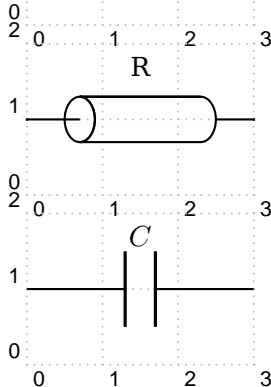

```
\begin{pspicture}[showgrid=true](3,2)
  \pnodes(0,1){A}(3,1){B}
  \RFLine(A)(B){R}
\end{pspicture}
```

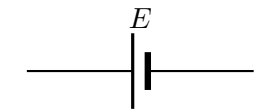

```
\begin{pspicture}[showgrid=true](3,2)
  \pnodes(0,1){A}(3,1){B}
  \capacitor(A)(B){C$}
\end{pspicture}
```

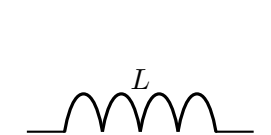

```
\begin{pspicture}(3,2)
  \pnodes(0,1){A}(3,1){B}
  \battery(A)(B){E$}
\end{pspicture}
```



```
\begin{pspicture}(3,2)
  \pnodes(0,1){A}(3,1){B}
  \coil(A)(B){L$}
\end{pspicture}
```

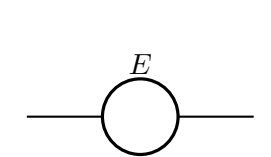

```
\begin{pspicture}(3,2)
  \pnodes(0,1){A}(3,1){B}
  \Ucc[dipolestyle=normal](A)(B){E$}
\end{pspicture}
```

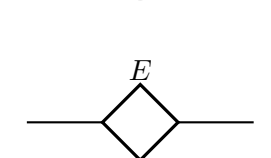

```
\begin{pspicture}(3,2)
  \pnodes(0,1){A}(3,1){B}
  \Ucc[dipolestyle=diamond](A)(B){E$}
\end{pspicture}
```

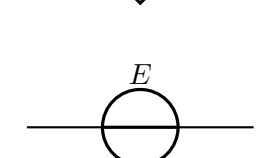

```
\begin{pspicture}(3,2)
  \pnodes(0,1){A}(3,1){B}
  \Ucc[dipolestyle=normalCeil](A)(B){E$}
\end{pspicture}
```

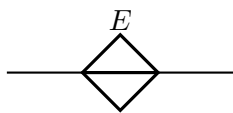

```
\begin{pspicture}(3,2)
  \pnodes(0,1){A}(3,1){B}
  \Ucc[dipolestyle=diamondCei](A)(B){$E$}
\end{pspicture}
```

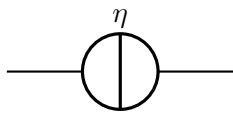

```
\begin{pspicture}(3,2)
  \pnodes(0,1){A}(3,1){B}
  \Icc[dipolestyle=normal](A)(B){$\eta$}
\end{pspicture}
```

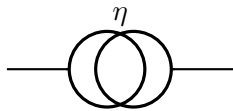

```
\begin{pspicture}(3,2)
  \pnodes(0,1){A}(3,1){B}
  \Icc[dipolestyle=twoCircles](A)(B){$\eta$}
\end{pspicture}
```

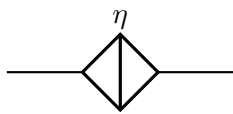

```
\begin{pspicture}(3,2)
  \pnodes(0,1){A}(3,1){B}
  \Icc[dipolestyle=diamond](A)(B){$\eta$}
\end{pspicture}
```

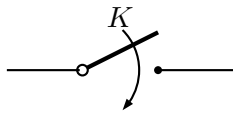

```
\begin{pspicture}(3,2)
  \pnodes(0,1){A}(3,1){B}
  \switch(A)(B){$K$}
\end{pspicture}
```

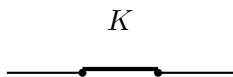

```
\begin{pspicture}(3,2)
  \pnodes(0,1){A}(3,1){B}
  \switch[dipolestyle=close](A)(B){$K$}
\end{pspicture}
```

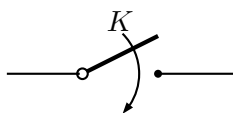

```
\begin{pspicture}(3,2)
  \pnodes(0,1){A}(3,1){B}
  \arrowswitch(A)(B){$K$}
\end{pspicture}
```

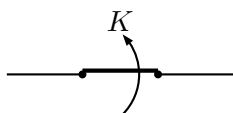

```
\begin{pspicture}(3,2)
  \pnodes(0,1){A}(3,1){B}
  \arrowswitch[dipolestyle=close](A)(B){$K$}
\end{pspicture}
```

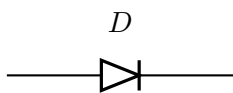

```
\begin{pspicture}(3,2)
  \pnodes(0,1){A}(3,1){B}
  \diode(A)(B){$D$}
\end{pspicture}
```

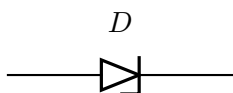

```
\begin{pspicture}(3,2)
  \pnodes(0,1){A}(3,1){B}
  \Zener(A)(B){$D$}
\end{pspicture}
```

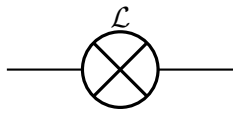

```
\begin{pspicture}(3,2)
 \pnodes(0,1){A}(3,1){B}
 \lamp(A)(B){$\mathcal L$}
 \end{pspicture}
```

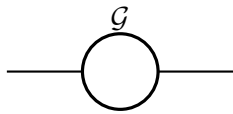

```
\begin{pspicture}(3,2)
 \pnodes(0,1){A}(3,1){B}
 \circledipole(A)(B){$\mathcal G$}
 \end{pspicture}
```

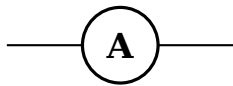

```
\begin{pspicture}(3,2)
 \pnodes(0,1){A}(3,1){B}
 \circledipole[labeloffset=0](A)(B){\Large\textbf{A}}
 \end{pspicture}
```

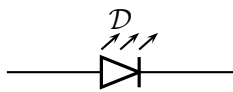

```
\begin{pspicture}(3,2)
 \pnodes(0,1){A}(3,1){B}
 \LED(A)(B){$\mathcal D$}
 \end{pspicture}
```

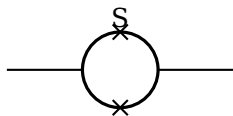

```
\begin{pspicture}(3,2)
 \pnodes(0,1){A}(3,1){B}
 \SQUID(A)(B){S}
 \end{pspicture}
```

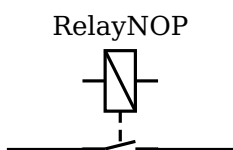

RelayNOP

```
\begin{pspicture}(3,3)
 \pnodes(0,0){A}(3,0){B}%Relay normally open
 \RelayNOP[labeloffset=1.6](A)(B){RelayNOP}
 \end{pspicture}
```



Suppressor

```
\begin{pspicture}(3,2)
 \pnodes(0,1){A}(3,1){B}% Suppressor (Diode)
 \Suppressor[labeloffset=0.5](A)(B){Suppressor}
 \end{pspicture}
```



Arrestor

```
\begin{pspicture}(3,2)
 \pnodes(0,1){A}(3,1){B}
 % Arrestor (Lightning protection)
 \Arrestor(A)(B){Arrestor}
 \end{pspicture}
```

Tripole macros

Obviously, tripoles are not node connections. So `pst-circ` tries its best to adjust the position of the tripole regarding the three nodes. Internally, the connections are done by the `\ncangle pst-node` macro. However, the auto-positioning and the auto-connections are not always well chosen, so don't try to use tripole macros in strange situations!

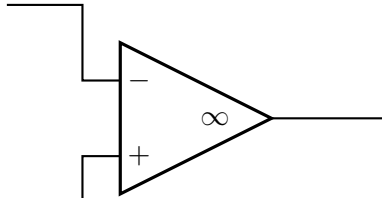

```
\begin{pspicture}(5,3)
\pnodes(0,0){A}(0,3){B}(5,1.5){C}
\OA(B)(A)(C)
\end{pspicture}
```

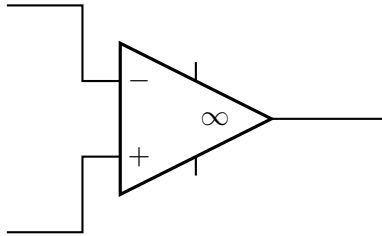

```
\begin{pspicture}(5,3)
\pnodes(0,0){A}(0,3){B}(5,1.5){C}
\OA[0Apower=true](B)(A)(C)
\end{pspicture}
```

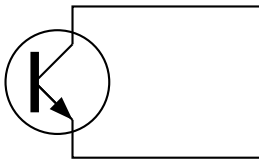

```
\begin{pspicture}(3,4)
\pnodes(0,2){A}(3,1){B}(3,3){C}
\transistor(A)(B)(C)
\end{pspicture}
```

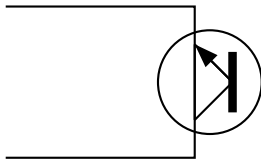

```
\begin{pspicture}(3,4)
\pnodes(3,2){A}(0,1){B}(0,3){C}
\transistor[TRot=180](A)(B)(C)
\end{pspicture}
```

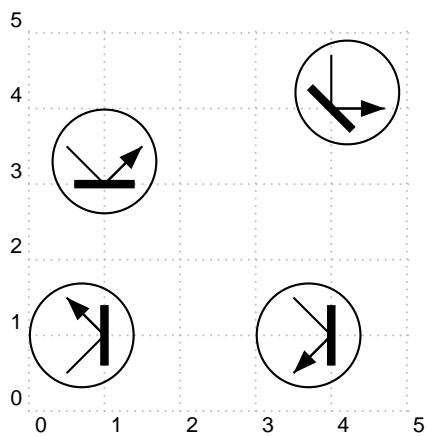

```
\begin{pspicture}[showgrid=true](5,5)
\pnode(1,3){b}
\transistor[TRot=90](b){emitter}{collector}
\transistor[TRot=45](4,4){emitter}{collector}
\transistor[TRot=180](1,1){emitter}{collector}
\transistor[TRot=180,transistorinvert=true]%(4,1){emitter}{collector}
\end{pspicture}
```

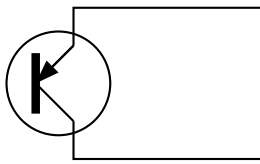

```
\begin{pspicture}(3,4)
\pnodes(0,2){A}(3,1){B}(3,3){C}
\transistor[transistortype=PNP](A)(B)(C)
\end{pspicture}
```

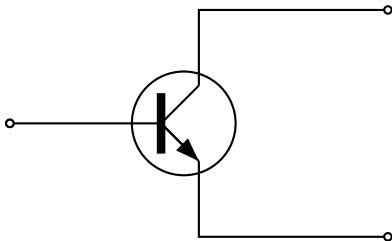

```
\begin{pspicture}(5,3)
\pnodes(0,1.5){A}(5,0){B}(5,3){C}
\transistor[basesep=2cm,arrows=o-o](A)(B)(C)
\end{pspicture}
```

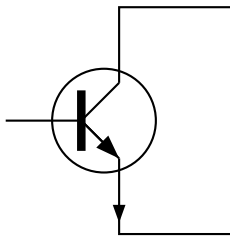

```
\begin{pspicture}(3,4)
\pnode(0,2){A}\pnode(3,0.5){B}
\pnode(3,3.5){C}
\transistor[transistoriemitter=true,
basesep=1cm](A)(B)(C)
\end{pspicture}
```

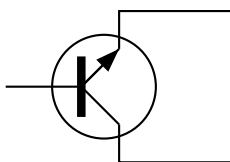

```
\begin{pspicture}(3,4)
\pnode(0,2){A}\pnode(3,1){B}
\pnode(3,3){C}
\transistor[transistorinvert,
basesep=1cm](A)(B)(C)
\end{pspicture}
```

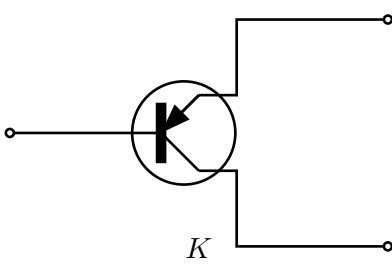

```
\begin{pspicture}(5,3)
\pnode(0,1.5){A}\psset{linewidth=1pt}
\transistor[transistortype=PNP,basesep=2cm,
arrows=o-o](A){Emitter}{Collector}
\psline{o-}(5,3)(3,3)(3,3|Collector)(Collector)
\psline{o-}(5,0)(3,0)(3,3|Emitter)(Emitter)
\psline{o-}(A)([nodesep=2]A)
\end{pspicture}
```

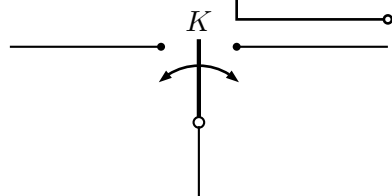

```
\begin{pspicture}(5,2)
\pnodes(0,2){A}(5,2){B}(0,0){C}
\Tswitch(A)(B)(C){$K$}
\end{pspicture}
```

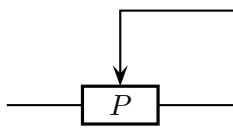
```
\begin{pspicture}(3,3)
 \pnodes(0,1){A}(3,1){B}(3,2.25){C}
 \potentiometer[labeloffset=0pt](A)(B)(C){$P$}
\end{pspicture}
```

```

\psset{mathlabel,labelstyle=\tt}
\def\pcTran(#1)(#2){\psline(#1)(#2|#1)(#2)}% only 2 segments
\psset{circedge=\pcTran,connectingdot=false}

\begin{pspicture}(10,10)
\pnodes(1,1){G1}(6,1){G2}(7.5,1){G3}
\newground[arrows=o](G1)\newground(G2)\newground(G3)
\pnodes(1,3){D1u}(7,3){T1B}(0,3){IB}(4,4){T2B}
\newdiode(G1)(D1u){D1}\qdisk(D1u){2pt}
\transistor[TRot=270,arrows=-o](T2B)(IB)(T1B)
\pnode(8,7){O1}%junction to out
\transistor(T1B)(G3)(O1)
\pnodes(1,6){D2u}(1,4){G4}
\newground(G4)
\newdiode(G4)(D2u){D2}\qdisk(D2u){2pt}
\pnodes(2.5,7){T4B}(0,6){IA}(5.5,5){T3B}(6,7){R3d}
\transistor[TRot=270,arrows=-o](T4B)(IA)(T3B)\uput[90](IA){\mathhtt{A}}
\transistor(T3B)(G2)(R3d)\uput[90](IB){\mathhtt{B}}
\pnodes(2.5,10){VCC1}(4,10){VCC2}(6,10){VCC3}
\resistor[arrows=o-](VCC1)(T4B){4{,}7k\Omega}
\resistor[arrows=o-](VCC2)(T2B){4{,}7k\Omega}
\resistor[arrows=o-](VCC3)(R3d){100\Omega}
\wire[arrows=-o](R3d)(O1)
\uput[90](O1){\mathhtt{OUT}} \qdisk(7.5,7){2pt}
\end{pspicture}

```

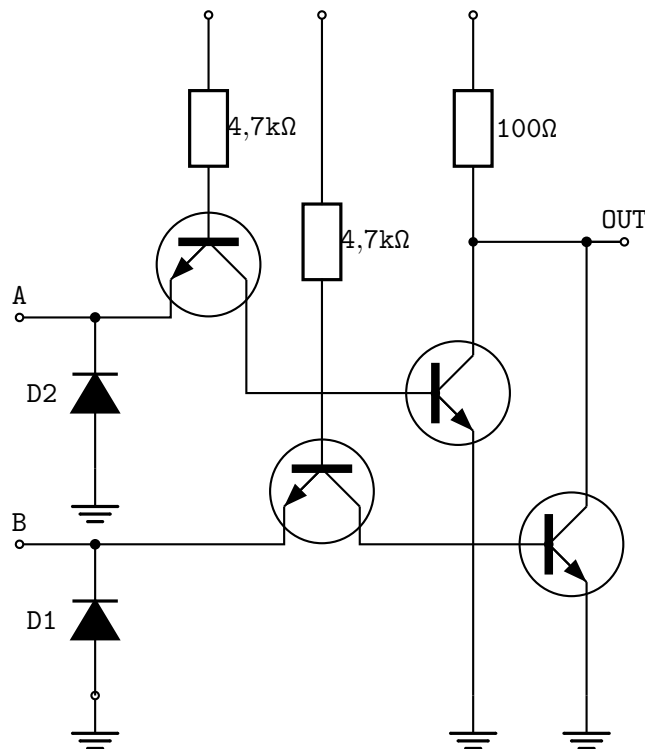

Quadrupole macros

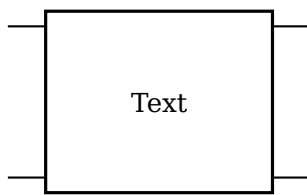

```
\begin{pspicture}(5,3)
 \pnodes(0,2.5){A}(0,0.5){B}%
 (4,2.5){C}(4,0.5){D}
 \quadripole(A)(B)(C)(D){Text}
 \end{pspicture}
```

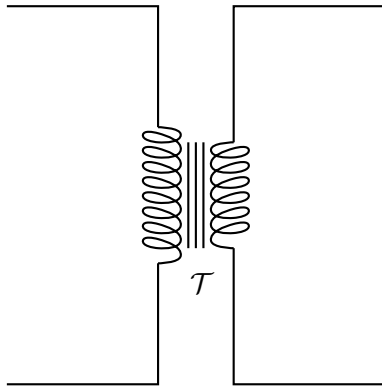

```
\begin{pspicture}(5,5)
 \pnodes(0,5){A}(0,0){B}%
 (5,5){C}(5,0){D}
 \transformer(A)(B)(C)(D){$\mathcal{T}$}
 \end{pspicture}
```

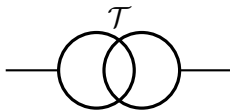

```
\begin{pspicture}(3,2)
 \pnodes(0,1){A}(3,1){B}
 \newtransformer(A)(B){$\mathcal{T}$}
 \end{pspicture}
```

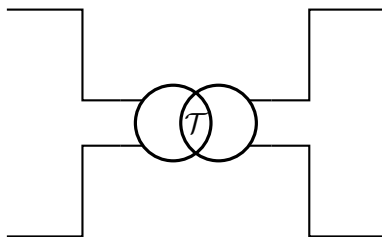

```
\begin{pspicture}(5,3)
 \pnodes(0,3){A}(0,0){B}%
 (5,3){C}(5,0){D}
 \newtransformerquad(A)(B)(C)(D)%
 {$\mathcal{T}$}
 \end{pspicture}
```

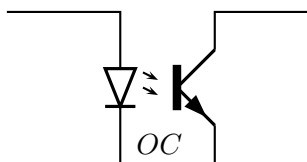

```
\begin{pspicture}(5,3)
 \pnodes(0,2.5){A}(0,0.5){B}%
 (4,2.5){C}(4,0.5){D}
 \optocoupler(A)(B)(C)(D){$OC$}
 \end{pspicture}
```

Multidipole

`\multidipole` is a macro that allows multiple dipoles to be drawn between two specified nodes. `\multidipole` takes as many arguments as you want. Note the dot that is after the last dipole.

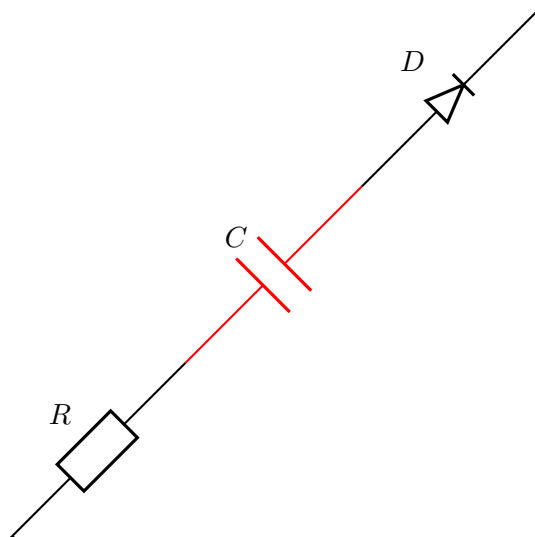

```
\begin{pspicture}(7,7)
  \pnodes(0,0){A}(7,7){B}
  \multidipole(A)(B)\resistor{$R$}%
  \capacitor[linecolor=red]{$C$}%
  \diode{$D$}{}.
\end{pspicture}
```

Important: for the time being, `\multidipole` takes optional arguments but does not restore original values. We recommend not using it.

Wire

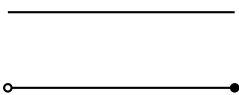

```
\begin{pspicture}(3,2)
  \pnodes(0,1){A}(3,1){B}\wire(A)(B)
  \pnodes(0,0){A}(3,0){B}\wire[arrows=o-*](A)(B)
\end{pspicture}
```

Potential

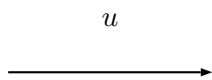

```
\begin{pspicture}(3,2)
  \pnodes(0,1){A}(3,1){B}
  \tension(A)(B){$u$}
\end{pspicture}
```

ground

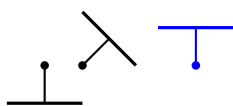

```
\begin{pspicture}(3,2)
  \pnodes(0.5,1){A}(1,1){B}(2.5,1){C}
  \ground(A)
  \ground{135}(B)
  \ground[linecolor=blue]{180}(C)
\end{pspicture}
```

Open dipol and open tripol

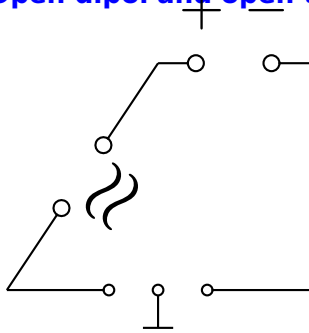

```
\def\Wave{\psscalebox{3}{\approx$}}
\def\PM{\psscalebox{2}{$+\,\,\,-$}}
\begin{pspicture}(4,3)
\pnodes(0,0){A}(2,3){B}(4,3){C}(4,0){D}
\OpenDipol[radius=3pt,labelangle=:U,
labeloffset=-0.5](A)(B){\Wave}
\OpenDipol[radius=3pt,labelangle=:U](B)(C){\PM}
\OpenTripol(A)(D){}
\end{pspicture}
```

1.3 Parameters

Label parameters

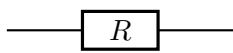

```
\begin{pspicture}(3,1)
\pnodes(0,.5){A}(3,.5){B}
\resistor[labeloffset=0](A)(B){$R$}
\end{pspicture}
```

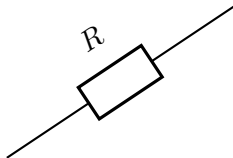

```
\begin{pspicture}(3,2)
\pnodes(0,0){A}(3,2){B}
\resistor[labelangle=:U](A)(B){$R$}
\end{pspicture}
```

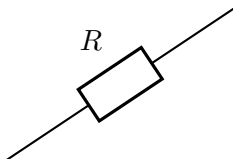

```
\begin{pspicture}(3,2)
\pnodes(0,0){A}(3,2){B}
\resistor[labelangle=0](A)(B){$R$}
\end{pspicture}
```

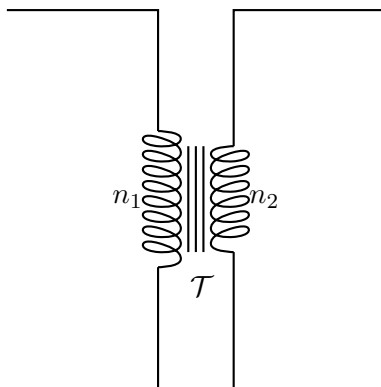

```
\begin{pspicture}(5,5)
\pnodes(0,5){A}(0,0){B}(5,5){C}(5,0){D}
\transformer[primarylabel=$n_1$,
secondarylabel=$n_2$](A)(B)(C)(D){\mathcal T}
\end{pspicture}
```

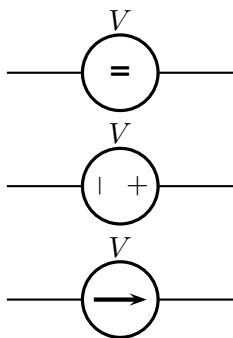

```
\begin{pspicture}(3,4.5)
\pnodes(0,.5){A}(3,.5){B}
\Ucc[labelInside=1](A)(B){$V$}
\pnodes(0,2){A}(3,2){B}
\Ucc[labelInside=2](A)(B){$V$}
\pnodes(0,3.5){A}(3,3.5){B}
\Ucc[labelInside=3](A)(B){$V$}
\end{pspicture}
```

Current intensity and electrical potential parameters

If the intensity parameter is set to true, an arrow is drawn on the wire connecting one of the nodes to the dipole. If the tension parameter is set to true, an arrow is drawn parallel to the dipole.

The way those arrows are drawn is set by `dipoleconvention` and `directconvention` parameters. `dipoleconvention` can take two values : `generator` or `receptor`. `directconvention` is a boolean.

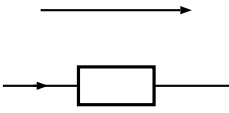
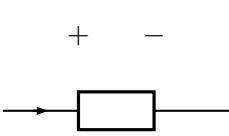
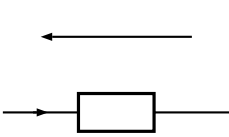
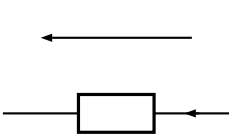
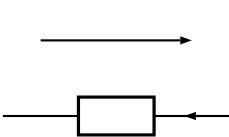
	<pre>\begin{pspicture}(3,2) \nodes(0,.5){A}(3,.5){B} \resistor[intensity,tension](A)(B){} \end{pspicture}</pre>
	<pre>\begin{pspicture}(3,2) \nodes(0,.5){A}(3,.5){B} \resistor[intensity,tension,tensionstyle=pm](A)(B){} \end{pspicture}</pre>
	<pre>\begin{pspicture}(3,2) \nodes(0,.5){A}(3,.5){B} \resistor[intensity,tension,dipoleconvention=generator](A)(B){} \end{pspicture}</pre>
	<pre>\begin{pspicture}(3,2) \nodes(0,.5){A}(3,.5){B} \resistor[intensity,tension,directconvention=false](A)(B){} \end{pspicture}</pre>
	<pre>\begin{pspicture}(3,2) \nodes(0,.5){A}(3,.5){B} \resistor[intensity,tension, dipoleconvention=generator,directconvention=false](A)(B){} \end{pspicture}</pre>

If `intensitylabel` is set to a non empty argument, then `intensity` is automatically set to true. If `tensionlabel` is set to a non empty argument, then `tension` is automatically set to true.

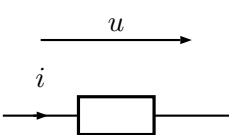
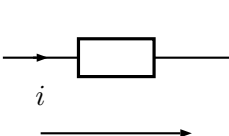
	<pre>\begin{pspicture}(3,2) \nodes(0,.5){A}(3,.5){B} \resistor[intensitylabel=\$i\$,tensionlabel=\$u\$](A)(B){} \end{pspicture}</pre>
	<pre>\begin{pspicture}(3,2) \nodes(0,1.5){A}(3,1.5){B} \resistor[intensitylabel=\$i\$,intensitylabeloffset=-0.5, tensionlabel=\$u\$,tensionlabeloffset=-1.2, tensionoffset=-1](A)(B){} \end{pspicture}</pre>

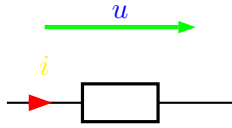

```
\begin{pspicture}(3,2)
\nodes(0,.5){A}(3,.5){B}
\resistor[intensitylabel=$i$,intensitywidth=3\pslinewidth,
intensitycolor=red,intensitylabelcolor=yellow,
tensionlabel=$u$,tensionwidth=2\pslinewidth,
tensioncolor=green,tensionlabelcolor=blue](A)(B){}
\end{pspicture}
```

Some specific intensity parameters are available for tripoles and quadrupoles.

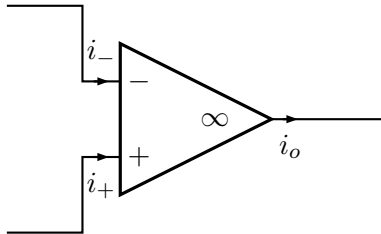

```
\begin{pspicture}(5,3)
\nodes(0,0){A}(0,3){B}(5,1.5){C}
\OA[OAipluslabel=$i_+$,
OAiminuslabel=$i_-$,
OAioutlabel=$i_o$](B)(A)(C)
\end{pspicture}
```

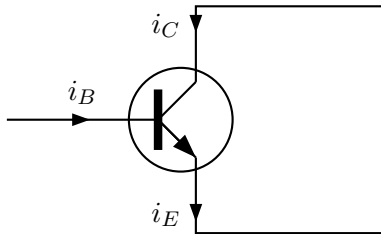

```
\begin{pspicture}(5,3)
\nodes(0,1.5){A}(5,0){B}(5,3){C}
\transistor[basesep=2cm,transistoribaselabel=$i_B$,
transistoricollectorlabel=$i_C$,
transistoriemitterlabel=$i_E$](A)(B)(C)
\end{pspicture}
```

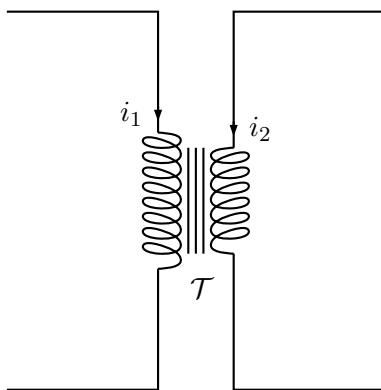

```
\begin{pspicture}(5,5)
\nodes(0,5){A}(0,0){B}(5,5){C}(5,0){D}
\transformer[transformerprimarylabel=$i_1$,
transformersecondarylabel=$i_2$](A)(B)(C)(D){\mathcal{T}}
\end{pspicture}
```

Parallel parameters

If the parallel parameter is set to true, the dipole is drawn parallel to the line connecting the nodes.

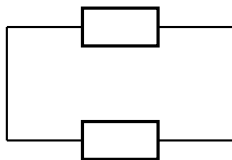

```
\begin{pspicture}(3,3)
\nodes(0,.5){A}(3,.5){B}
\resistor(A)(B){}
\resistor[parallel](A)(B){}
\end{pspicture}
```

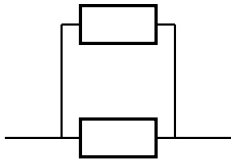

```
\begin{pspicture}(3,3)
  \pnodes(0,.5){A}(3,.5){B}
  \resistor(A)(B){}
  \resistor[parallel,parallelsep=.5](A)(B){}
\end{pspicture}
```

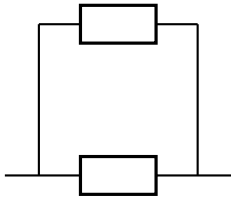

```
\begin{pspicture}(3,3)
  \pnodes(0,.5){A}(3,.5){B}
  \resistor(A)(B){}
  \resistor[parallel,parallelsep=.3,
    parallelarm=2](A)(B){}
\end{pspicture}
```

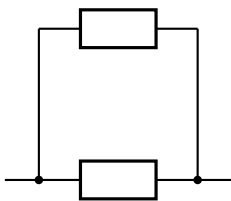

```
\begin{pspicture}(3,3)
  \pnodes(0,.5){A}(3,.5){B}
  \resistor(A)(B){}
  \resistor[parallel,parallelsep=.3,
    parallelarm=2,parallelnode](A)(B){}
\end{pspicture}
```

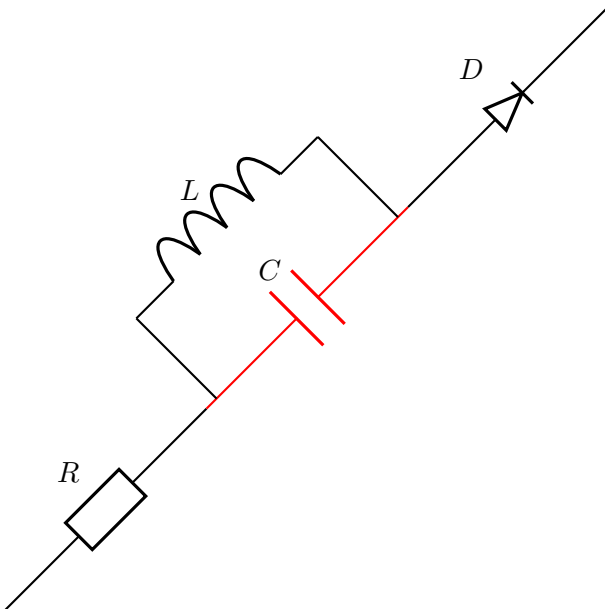

```
\begin{pspicture}(8,8)
  \pnodes(0,0){A}(8,8){B}
  \multidipole(A)(B)\resistor{R}%
  \capacitor[linecolor=red]{C}%
  \coil[parallel,parallelsep=.1]{L}%
  \diode{D}.
\end{pspicture}
```

Note: When used with `\multidipole`, the `parallel` parameter must not be set for the first dipole.

Wire intersections

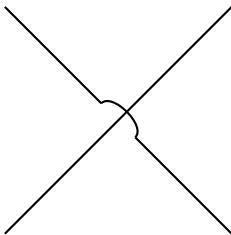

```
\begin{pspicture}(3,3)
  \pnodes(0,0){A}(3,3){B}(0,3){C}(3,0){D}
  \wire(A)(B)
  \wire[intersect,intersectA=A,intersectB=B](C)(D)
\end{pspicture}
```

Wire intersect parameters work also with `\multidipole`.

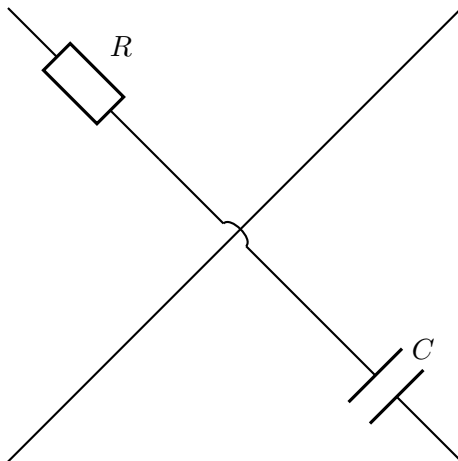

```
\begin{pspicture}(7,7)
  \pnodes(0,0){A}(6,6){B}(0,6){C}(6,0){D}
  \wire(A)(B)
  \multidipole(C)(D)\resistor{$R$}%
  \wire[intersect,intersectA=A,intersectB=B]%
  \capacitor{$C$}.
\end{pspicture}
```

Dipole style parameters

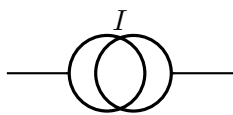

```
\begin{pspicture}(3,2)
  \pnodes(0,1){A}(3,1){B}
  \Icc[dipolestyle=twoCircles](A)(B){I$}
\end{pspicture}
```

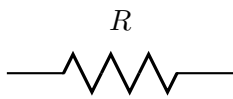

```
\begin{pspicture}(3,2)
  \pnodes(0,1){A}(3,1){B}
  \resistor[dipolestyle=zigzag](A)(B){R$}
\end{pspicture}
```

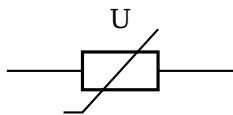

```
\begin{pspicture}(3,2)
  \pnodes(0,1){A}(3,1){B}
  \resistor[dipolestyle=varistor](A)(B){U}
\end{pspicture}
```

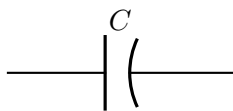

```
\begin{pspicture}(3,2)
  \pnodes(0,1){A}(3,1){B}
  \capacitor[dipolestyle=chemical](A)(B){C$}
\end{pspicture}
```

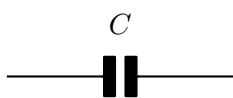

```
\begin{pspicture}(3,2)
  \pnodes(0,1){A}(3,1){B}
  \capacitor[dipolestyle=elektor](A)(B){C$}
\end{pspicture}
```

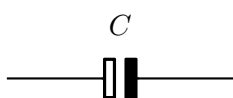

```
\begin{pspicture}(3,2)
  \pnodes(0,1){A}(3,1){B}
  \capacitor[dipolestyle=elektorchemical](A)(B){C$}
\end{pspicture}
```

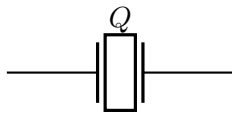

```
\begin{pspicture}(3,2)
  \pnodes(0,1){A}(3,1){B}
  \capacitor[dipolestyle=crystal](A)(B){$Q$}
\end{pspicture}
```

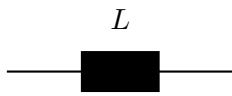

```
\begin{pspicture}(3,2)
  \pnodes(0,1){A}(3,1){B}
  \coil[dipolestyle=rectangle](A)(B){$L$}
\end{pspicture}
```

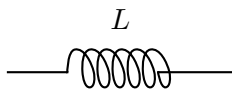

```
\begin{pspicture}(3,2)
  \pnodes(0,1){A}(3,1){B}
  \coil[dipolestyle=curved](A)(B){$L$}
\end{pspicture}
```

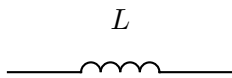

```
\begin{pspicture}(3,2)
  \pnodes(0,1){A}(3,1){B}
  \coil[dipolestyle=elektor](A)(B){$L$}
\end{pspicture}
```

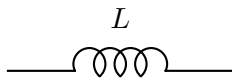

```
\begin{pspicture}(3,2)
  \pnodes(0,1){A}(3,1){B}
  \coil[dipolestyle=elektorcurved](A)(B){$L$}
\end{pspicture}
```

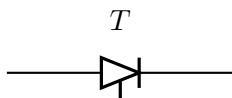

```
\begin{pspicture}(3,2)
  \pnodes(0,1){A}(3,1){B}
  \diode[dipolestyle=thyristor](A)(B){$T$}
\end{pspicture}
```

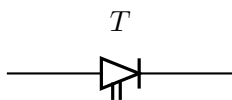

```
\begin{pspicture}(3,2)
  \pnodes(0,1){A}(3,1){B}
  \diode[dipolestyle=GT0](A)(B){$T$}
\end{pspicture}
```

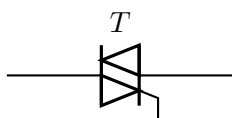

```
\begin{pspicture}(3,2)
  \pnodes(0,1){A}(3,1){B}
  \diode[dipolestyle=triac](A)(B){$T$}
\end{pspicture}
```

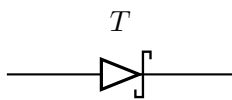

```
\begin{pspicture}(3,2)
  \pnodes(0,1){A}(3,1){B}
  \diode[dipolestyle=schottky](A)(B){$T$}
\end{pspicture}
```

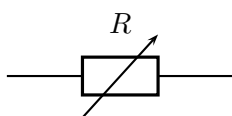

```
\begin{pspicture}(3,2)
  \pnodes(0,1){A}(3,1){B}
  \resistor[variable](A)(B){$R$}
\end{pspicture}
```

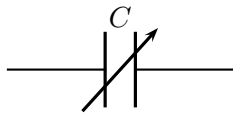

```
\begin{pspicture}(3,2)
  \pnodes(0,1){A}(3,1){B}
  \capacitor[variable](A)(B){$C$}
\end{pspicture}
```

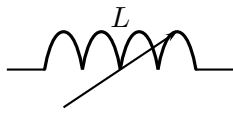

```
\begin{pspicture}(3,2)
  \pnodes(0,1){A}(3,1){B}
  \coil[variable](A)(B){$L$}
\end{pspicture}
```

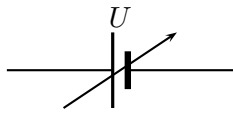

```
\begin{pspicture}(3,2)
  \pnodes(0,1){A}(3,1){B}
  \battery[variable](A)(B){$U$}
\end{pspicture}
```

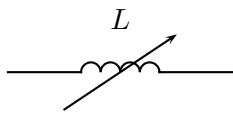

```
\begin{pspicture}(3,2)
  \pnodes(0,1){A}(3,1){B}
  \coil[dipolestyle=elektor,variable](A)(B){$L$}
\end{pspicture}
```

In the following example the parameter `dipolestyle` is used for a tripole and quadrupole, because the coils are drawn as rectangles and the resistor as a zigzag.

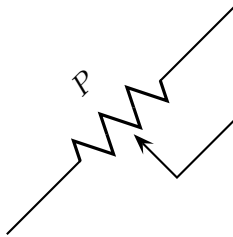

```
\begin{pspicture}(3,3)
  \pnodes(0,0){A}(3,3){B}(3,1.5){C}
  \potentiometer[dipolestyle=zigzag,%
    labelangle=:U](A)(B)(C){$P$}
\end{pspicture}
```

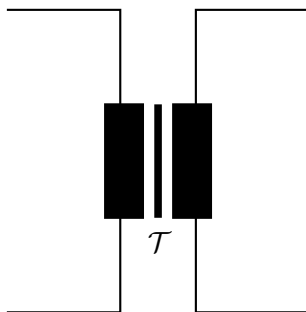

```
\begin{pspicture}(4,4)
  \pnodes(0,4){A}(0,0){B}(4,4){C}(4,0){D}
  \transformer[dipolestyle=rectangle](A)(B)(C)(D){$\mathcal{T}$}
\end{pspicture}
```

Tripole style parameters

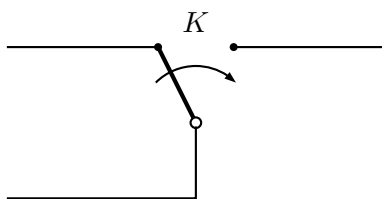

```
\begin{pspicture}(5,3)
  \pnodes(0,2){A}(5,2){B}(0,0){C}
  \Tswitch[tripolestyle=left](A)(B)(C){$K$}
\end{pspicture}
```

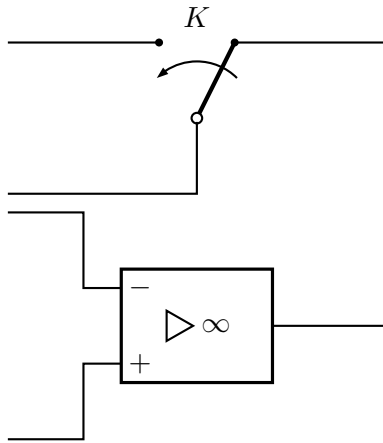

```
\begin{pspicture}(5,3)
  \pnodes(0,2){A}(5,2){B}(0,0){C}
  \Tswitch[tripolestyle=right](A)(B)(C){K$}
\end{pspicture}
```

```
\begin{pspicture}(5,3)
  \pnodes(0,3){A}(0,0){B}(5,1.5){C}
  \OA[tripolestyle=french](A)(B)(C)
\end{pspicture}
```

Tripoles

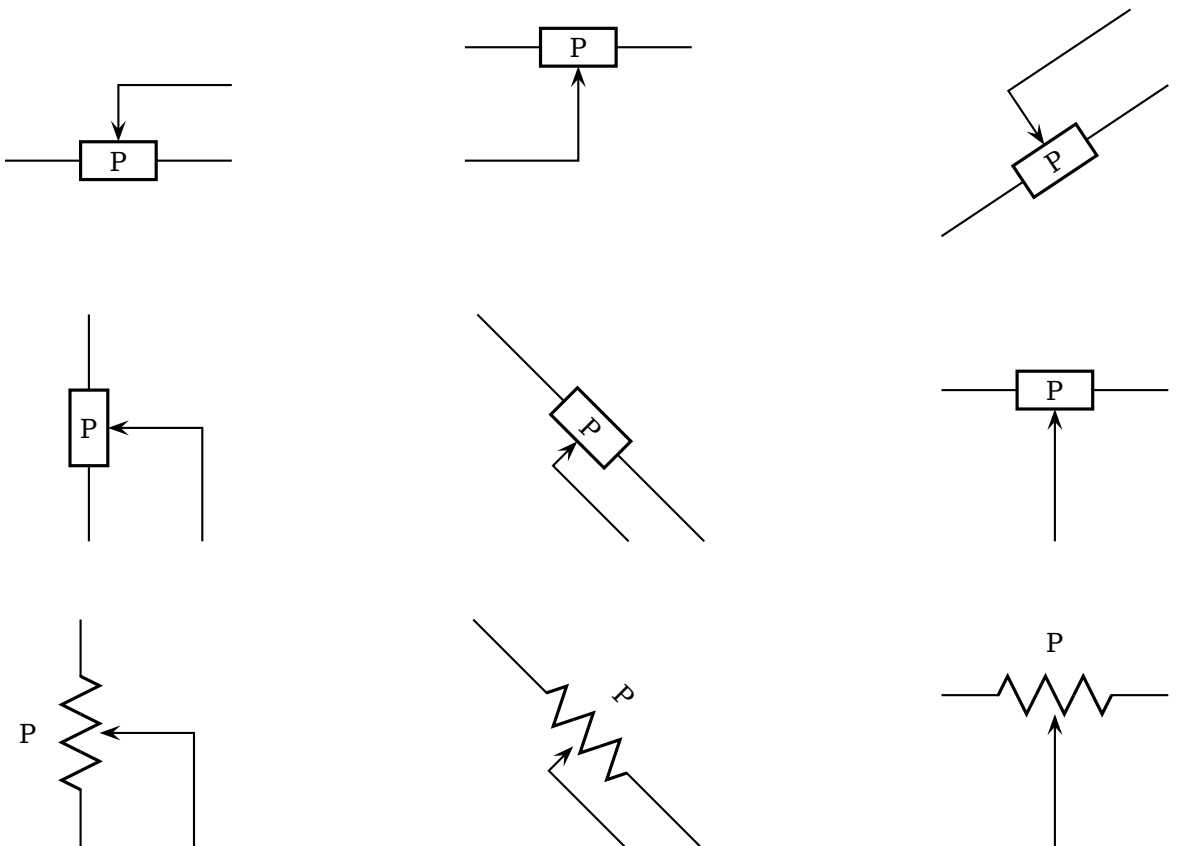

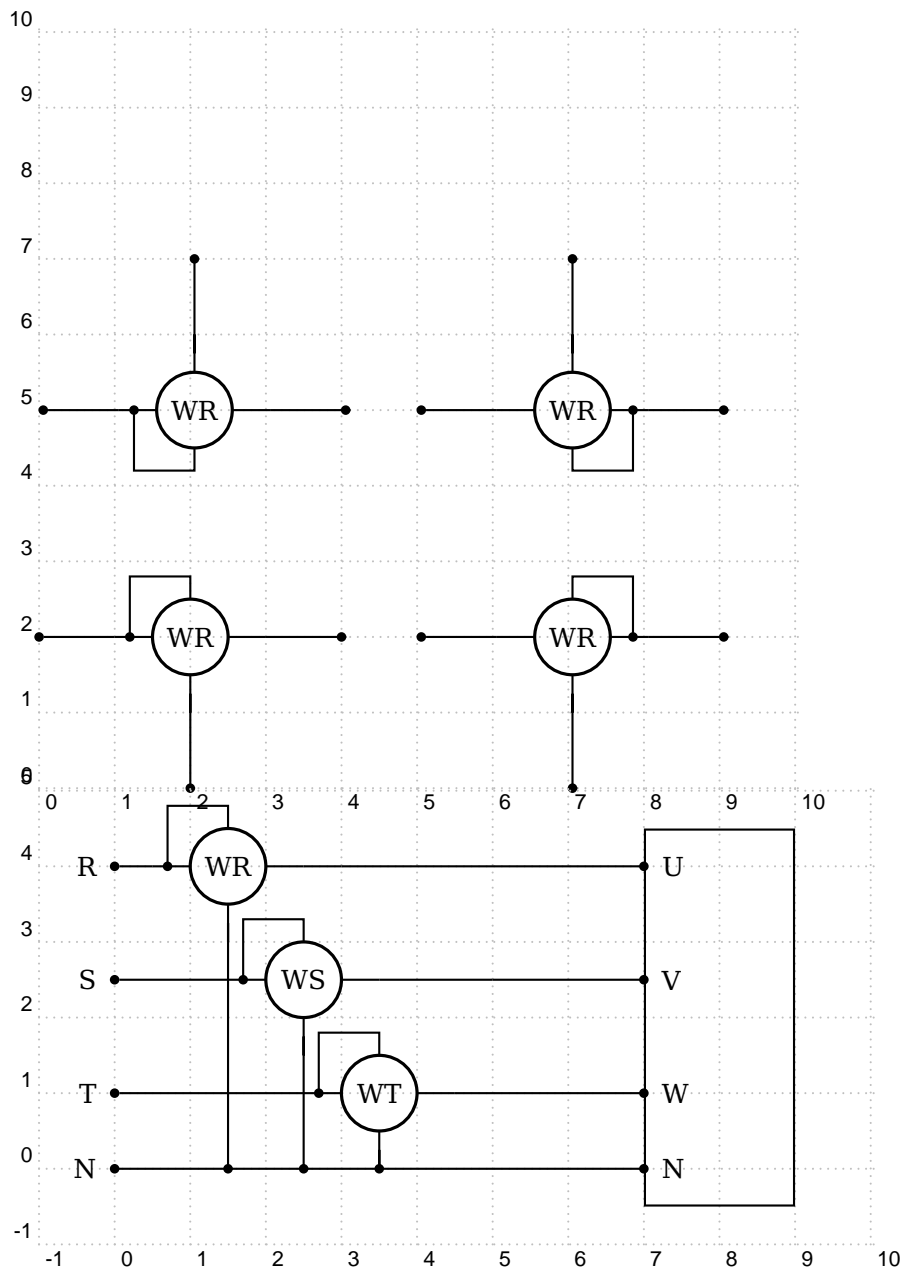

Other Parameters

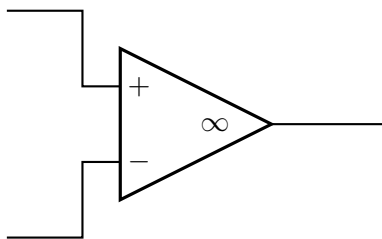

```
\begin{pspicture}(5,3)
  \pnodes(0,0){A}(0,3){B}(5,1.5){C}
  \OA[0Ainvert=false](B)(A)(C)
\end{pspicture}
```

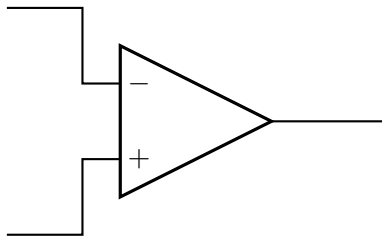

```
\begin{pspicture}(5,3)
\pnodes(0,0){A}(0,3){B}(5,1.5){C}
\OA[OAperfect=false](B)(A)(C)
\end{pspicture}
```

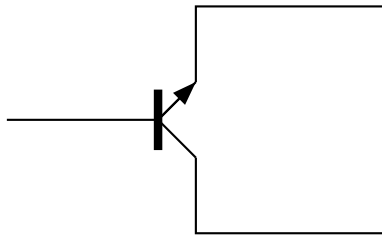

```
\begin{pspicture}(5,3)
\pnodes(0,1.5){A}(5,0){B}(5,3){C}
\transistor[basesep=2cm,%
transistorinvert,transistorcircle=false](A)(B)(C)
\end{pspicture}
```

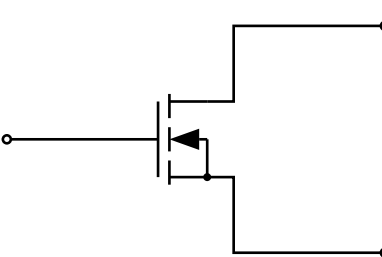

```
\begin{pspicture}(5,3)
\pnode(0,1.5){A}\psset{linewidth=1pt}
\transistor[basesep=2cm,arrows=o-o,
transistorinvert,transistorcircle=false](A){Emitter}{Collector}
\psline{o-}(5,3)(3,3)(3,3|Collector)(Collector)
\psline{o-}(5,0)(3,0)(3,3|Emitter)(Emitter)
\psline{o-}(A)([nodesep=2]A)
\end{pspicture}
```

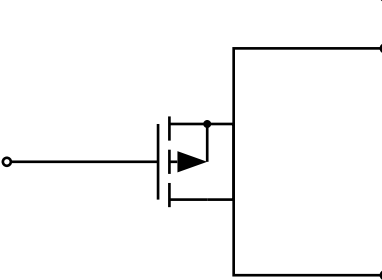

```
\begin{pspicture}(5,3)
\pnode(0,1.5){A}\psset{linewidth=1pt}
\transistor[basesep=2cm,arrows=o-o,
transistorinvert,transistorcircle=false](A){Emitter}{Collector}
\psline{o-}(5,3)(3,3)(3,3|Collector)(Collector)
\psline{o-}(5,0)(3,0)(3,3|Emitter)(Emitter)
\psline{o-}(A)([nodesep=2]A)
\end{pspicture}
```

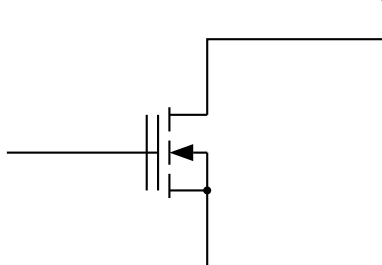

```
\begin{pspicture}(5,3)
\transistor[basesep=2cm,transistorinvert,transistorcircle=false,
FETmemory=true](0,1.5)(5,0)(5,3)
\end{pspicture}
```

1.4 Special objects

\dashpot

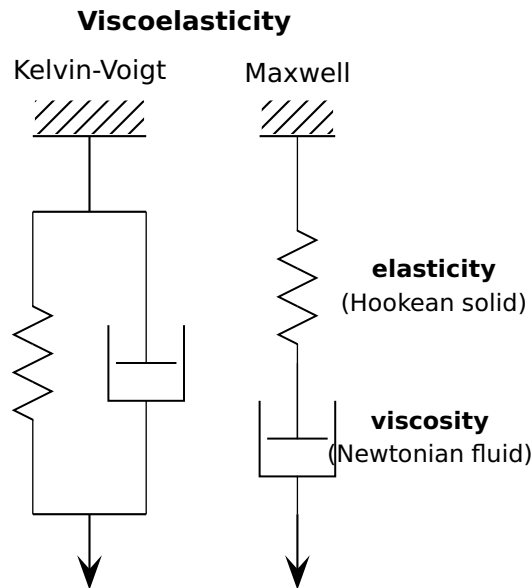

```

\newcommand*\pswall[3]{% ll ur lr
  \psframe[linecolor=white,fillstyle=hlines,hatchcolor=black](#1)(#2)% (ll)(ur)
  \psline[linecolor=black](#1)(#3)}
\begin{pspicture}(0.5,1)(8,10)
  \rput(3,9.5){\sffamily \textbf{Viscoelasticity}}
  % Kelvin-Voigt model (spring and dashpot parallel): =====
  \rput[c](1.75,8.85){\sffamily Kelvin-Voigt}
  \pswall{1,8}{2.5,8.5}{2.5,8}% top
  \psline(1.75,8)(1.75,7)% top vertical line
  % node definitions:
  \pnodes(1,7){ul1}(2.5,7){ur1}(1,3){ll1}(2.5,3){lr1}%
  \psline(ul1)(ur1)% top line
  \psline(ll1)(lr1)% bottom line
  \resistor[dipolestyle=zigzag,linewidth=0.5pt](ul1)(ll1){}% spring
  \dashpot[linewidth=0.5pt](ur1)(lr1){}% dashpot
  \psline[arrowscale=3]{->}(1.75,3)(1.75,2)% force
  % Maxwell model (spring and dashpot serial): =====
  \rput[c](4.5,8.85){\sffamily Maxwell}
  \pswall{4,8}{5,8.5}{5,8}% top
  \pnodes(4.5,8){t}(4.5,4){b}% node definitions
  \resistor[dipolestyle=zigzag,linewidth=0.5pt,labeloffset=1.8](t)(b)% spring
  {\sffamily\small\begin{tabular}{c}\textbf{elasticity}\(Hookean solid)\end{tabular}}%
  end spring
  \dashpot[linewidth=0.5pt,labeloffset=1.8](4.5,5)(4.5,3)% dashpot
  {\sffamily\small\begin{tabular}{c}\textbf{viscosity}\(Newtonian fluid)\end{tabular}}
  % end dashpot
  \psline[arrowscale=3]{->}(4.5,3)(4.5,2)% force
\end{pspicture}

```

2 Modified default symbols

2.1 Dipole

New Diode

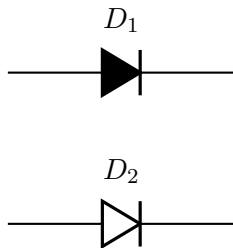

```
\begin{pspicture}[showgrid=false](3,4)
  \pnodes(0,1){A}(3,1){B}(0,3){C}(3,3){D}
  \newdiode(C)(D){$D_1$}
  \newdiode[ison=false](A)(B){$D_2$}
\end{pspicture}
```

New Zener

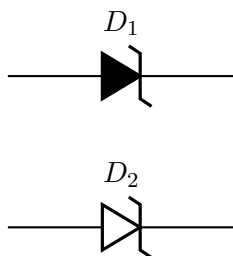

```
\begin{pspicture}[showgrid=false](3,4)
  \pnodes(0,1){A}(3,1){B}(0,3){C}(3,3){D}
  \newZener(C)(D){$D_1$}
  \newZener[ison=false](A)(B){$D_2$}
\end{pspicture}
```

New LED

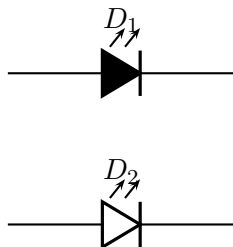

```
\begin{pspicture}[showgrid=false](3,4)
  \pnodes(0,1){A}(3,1){B}(0,3){C}(3,3){D}
  \newLED(C)(D){$D_1$}
  \newLED[ison=false](A)(B){$D_2$}
\end{pspicture}
```

New Ideal Switch

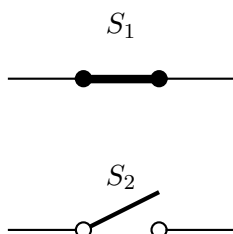

```
\begin{pspicture}[showgrid=false](3,4)
  \pnodes(0,1){A}(3,1){B}(0,3){C}(3,3){D}
  \newSwitch(C)(D){$S_1$}
  \newSwitch[ison=false](A)(B){$S_2$}
\end{pspicture}
```

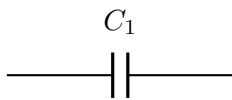
New Capacitor

```
\begin{pspicture}[showgrid=false](3,2)
  \pnodes(0,1){A}(3,1){B}
  \newcapacitor(A)(B){$C_1$}
\end{pspicture}
```

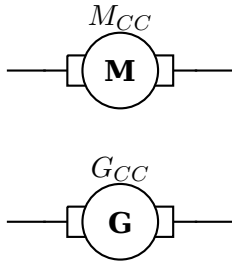
New Armature (motor or generator)

```
\begin{pspicture}[showgrid=false](3,4)
  \pnodes(0,1){A}(3,1){B}(0,3){C}(3,3){D}
  \newarmature[labelInside=1](C)(D){$M_{CC}$}
  \newarmature[labelInside=2](A)(B){$G_{CC}$}
\end{pspicture}
```

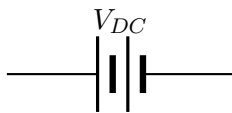
V DC

```
\begin{pspicture}[showgrid=false](3,2)
  \pnodes(0,1){A}(3,1){B}
  \vdc(A)(B){$V_{DC}$}
\end{pspicture}
```

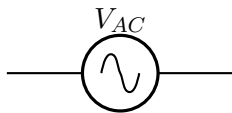
V AC

```
\begin{pspicture}[showgrid=false](3,2)
  \pnodes(0,1){A}(3,1){B}
  \vac(A)(B){$V_{AC}$}
\end{pspicture}
```

3 Examples

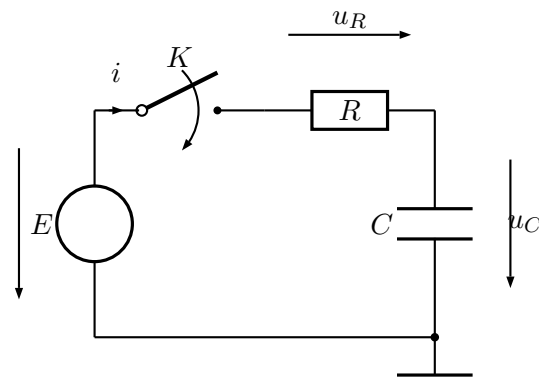

```

\begin{pspicture}(-1.5,-1)(6,5)
\pnodes(0,0){A}(0,3){B}(4.5,3){C}(4.5,0){D}
\Ucc[tension,dipoleconvention=generator](A)(B){$E$}
\multidipole(B)(C)%
\switch[intensitylabel=$i$]{$K$}%
\resistor[labeloffset=0,tensionlabel=$u_R$]{$R$}.
\capacitor[tensionlabel={$u_C$},tensionlabeloffset=-1.2,
tensionoffset=-1,directconvention=false](D)(C){$C$}
\wire(A)(D)
\ground(D)
\end{pspicture}

```

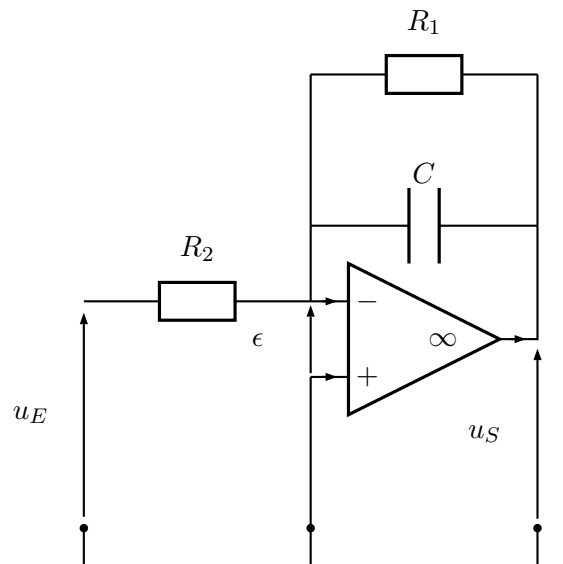

```

\begin{pspicture}(-0.5,0)(7,8)
\pnodes(0.5,1){A}(3.5,1){B}(6.5,1){C}(0.5,4){D}(3.5,4){Minus}
(3.5,3){Plus}(6.5,5){S}(3.5,5){E}
\resistor(D)(Minus){$R_2$}
\capacitor(E)(S){$C$}
\resistor[parallel,parallelarm=2](E)(S){$R_1$}
\OA[intensity](Minus)(Plus)(S)
\wire(Minus)(E)
\wire(Plus)(B)
\tension(A)(D){$u_E$}
\makeatletter % (special tricks see below)
\tension(C)(S@@){$u_S$}
\tension[linecolor=blue](Plus@@)(Minus@@){$\epsilon$}
\makeatother
\ground(A)\ground(B)\ground(C)
\end{pspicture}

```

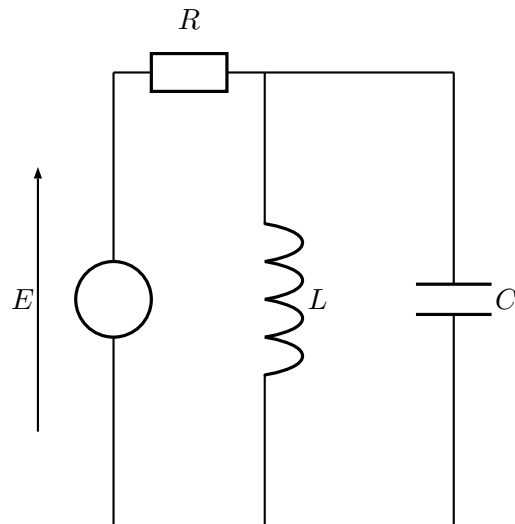

```
\begin{pspicture}(-1,0)(7,8)
\pnodes(1,1){A}(1,7){B}(3,1){C}(3,7){D}
\Ucc[tensionlabel=$E$](A)(B){}
\resistor(B)(D){$R$}
\coil(D)(C){$L$}
\capacitor[parallel,parallellarm=2.5](D)(C){$C$}
\wire(A)(C)
\end{pspicture}
```

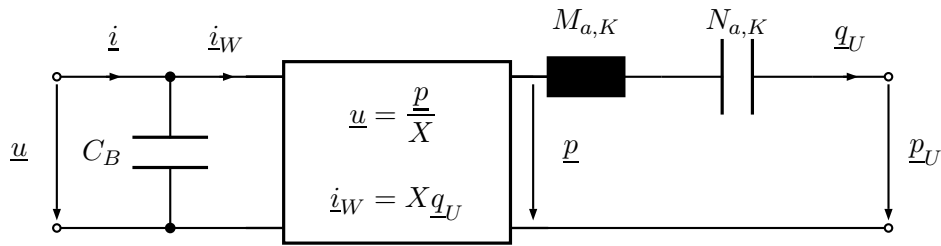

```

% \usepackage{amsmath} % example by Markus Graube
\begin{pspicture}(0,.5)(13,4)
\pnodes(1,1){I_U}(1,3){I_0}(2.5,1){C}(2.5,3){D}(4,1){K_LU}(4,3){K_L0}(7,1){K_RU}%
(7,3){K_R0}(9,3){E}(7.3,3){K_R01}(7.3,1){K_RU1}(11,3){F}(12,1){O_U}(12,3){O_0}
\tension[labeloffset=-0.5](I_0)(I_U){\underline{u}}$}
\wire[arrows=o-](I_U)(C)
\wire[intensitylabel=\underline{i}$, arrows=o-](I_0)(D)
\capacitor[labeloffset=.9](C)(D){$C_B$}
\qdisk(C){2pt} \qdisk(D){2pt}
\wire(C)(K_LU)
\wire[intensitylabel=\underline{i}_W$](D)(K_L0)
\quadripole(K_L0)(K_LU)(K_R0)(K_RU){\parbox{3cm}{%
\begin{align*}
\underline{u} &= \frac{\underline{p}}{X} \\
\underline{i}_W &= X \underline{q}_U
\end{align*}}
\end{align*}}
\wire(K_R0)(K_R01)
\tension[labeloffset=0.5](K_R01)(K_RU1){\underline{p}}$}
\coil[dipolestyle=rectangle](K_R0)(E){$M_{a,K}$}
\capacitor(E)(F){$N_{a,K}$}
\wire[intensitylabel=\underline{q}_U$, arrows=-o](F)(O_0)
\wire[arrows=-o](K_RU)(O_U)
\tension[labeloffset=0.5](O_0)(O_U){\underline{p}_U}$}
\end{pspicture}

```

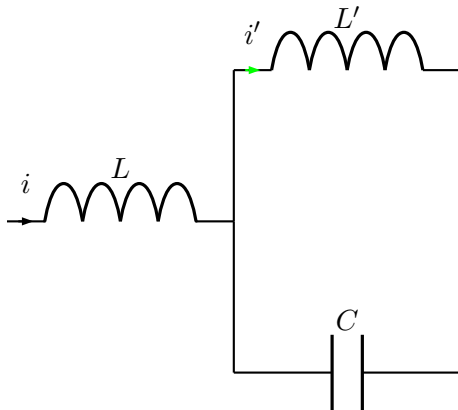

```

\begin{pspicture}(-0.25,-0.25)(6,6)
\pnodes(0,3){A}(3,3){B}(6,3){C}
% Dipole node connections
\coil[intensitylabel=$i$](A)(B){$L$}
\coil[intensitylabel=$i'$,
intensitycolor=green,%
parallel,parallellarm=2](B)(C){$L'$}
\capacitor[parallel,parallellarm=-2](
B)(C){$C$}
\end{pspicture}

```

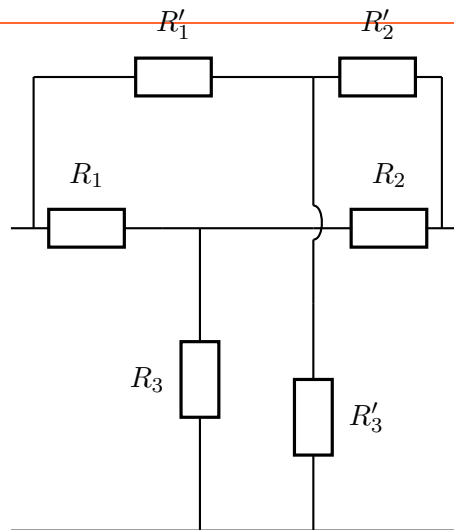

```

\begin{pspicture}(6,6)
\pnodes(0,0){A}(6,0){B}(0.3,4){Cprime}(5.7,4){Dprime}(2.5,4){Gprime}%
(2.5,0){Hprime}(0,4){C}(6,4){D}(0.3,6){E}(5.7,6){F}(4,6){G}(4,0){H}
\multidipole(G)(H)%
\wire[intersect,
intersectA=C,intersectB=D]
\resistor{$R'_3$}.
\resistor(E)(G){$R'_1$}
\resistor(G)(F){$R'_2$}
\multidipole(C)(D)\resistor{$R_1$}%
\wire\resistor{$R_2$}.
\wire(A)(B)\wire(Cprime)(E)
\wire(Dprime)(F)
\resistor(Hprime)(Gprime){$R_3$}
\end{pspicture}

```

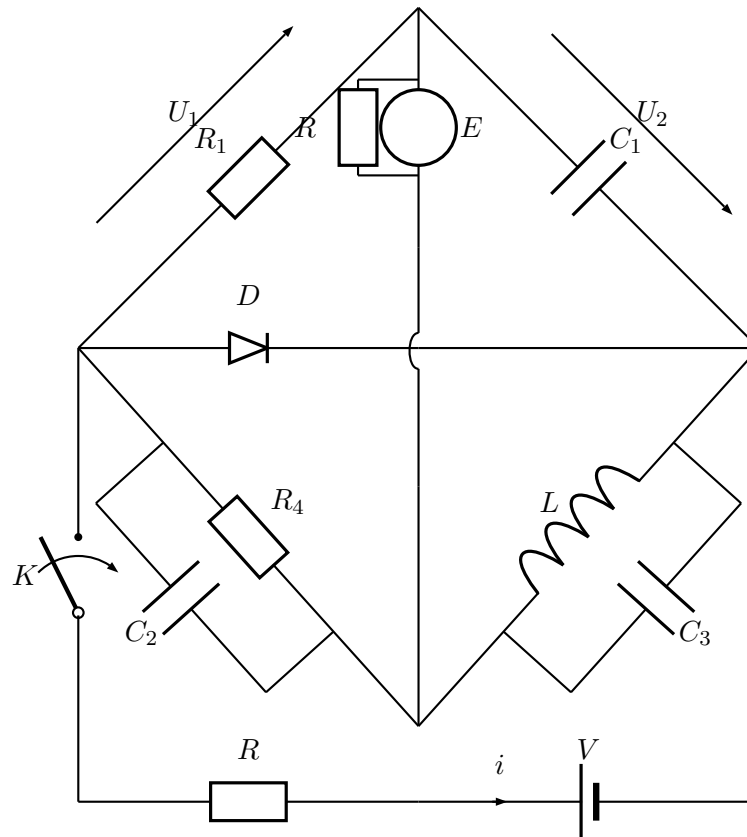

```

\begin{pspicture}(0,-0.25)(9,11)
\pnodes(0,0){A}(9,0){B}(0,6){C}(9,6){D}(4.5,1){E}(4.5,10.5){F}
\switch(A)(C){$K$}
\multidipole(A)(B)\resistor{$R_1$}\battery[intensitylabel=$i$]{$V$}.
\wire(B)(D)
\multidipole(C)(D)\diode{$D$}\wire.
\resistor[tensionlabel=$U_1$](C)(F){$R_1$} \resistor(C)(E){$R_4$}
\capacitor[parallel,parallelarm=1.2,parallese=1.5](C)(E){$C_2$}
\coil(E)(D){$L$}
\capacitor[parallel,parallelarm=1.2,parallese=1.5](E)(D){$C_3$}
\capacitor[tensionlabel=$U_2$](F)(D){$C_1$}
\multidipole(E)(F)\wire\wire[intersect,intersectA=C,intersectB=D]%
\circledipole[labeloffset=-0.7]{$E$}%
\resistor[parallel,parallese=.6,parallelarm=.8]{$R$}.
\end{pspicture}

```

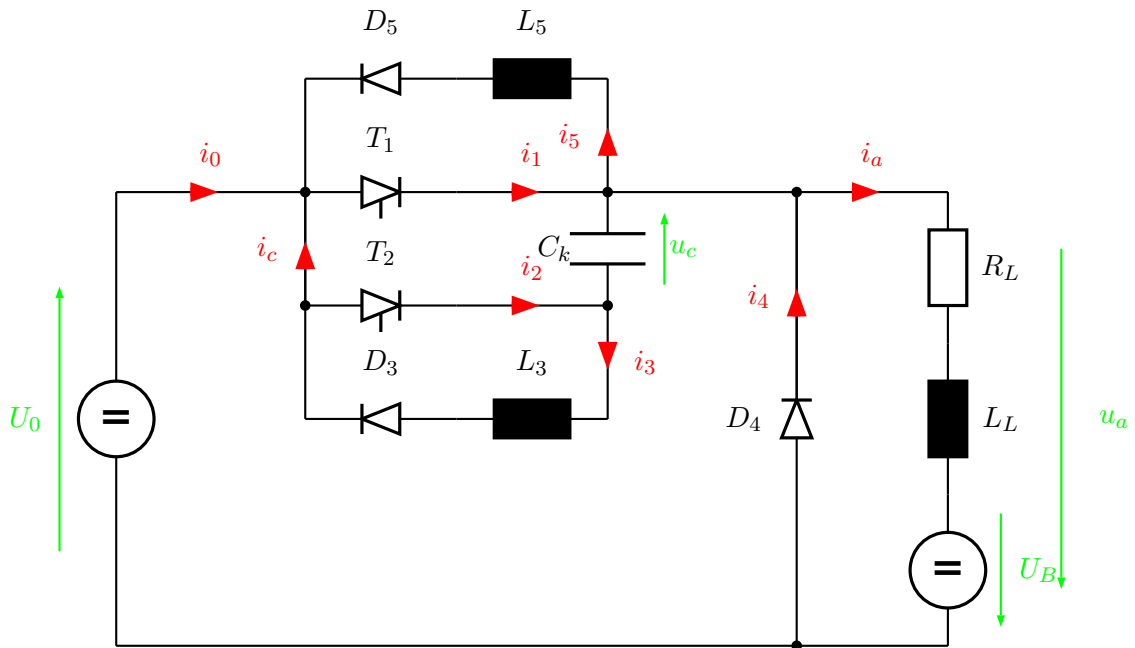

```

\begin{pspicture}(0,-0.2)(13,8)
\psset{intensitycolor=red,intensitylabelcolor=red,tensioncolor=green,
tensionlabelcolor=green,intensitywidth=3pt}
\circledipole[tension,tensionlabel=$U_0$,
tensionoffset=0.75,labeloffset=0](0,0)(0,6){\LARGE\textbf{=}}
\wire[intensity,intensitylabel=$i_0$](0,6)(2.5,6)
\diode[dipolestyle=thyristor](2.5,6)(4.5,6){$T_1$}
\wire[intensity,intensitylabel=$i_1$](4.5,6)(6.5,6)
\multidipole(6.5,7.5)(2.5,7.5)%
\coil[dipolestyle=rectangle,labeloffset=-0.75]{$L_5$}%
\diode[labeloffset=-0.75]{$D_5$}.
\wire[intensity,intensitylabel=$i_5$](6.5,6)(6.5,7.5)
\wire(2.5,7.5)(2.5,3)
\wire[intensity,intensitylabel=$i_c$](2.5,4.5)(2.5,6)
\qdisk(2.5,6){2pt}\qdisk(6.5,6){2pt}
\diode[dipolestyle=thyristor](2.5,4.5)(4.5,4.5){$T_2$}
\wire[intensity,intensitylabel=$i_2$](4.5,4.5)(6.5,4.5)
\capacitor[tension,tensionlabel=$u_c$,tensionoffset=-0.75,
tensionlabeloffset=-1](6.5,4.5)(6.5,6){$C_k$}
\qdisk(2.5,4.5){2pt}\qdisk(6.5,4.5){2pt}
\wire[intensity,intensitylabel=$i_3$](6.5,4.5)(6.5,3)
\multidipole(6.5,3)(2.5,3)%
\coil[dipolestyle=rectangle,labeloffset=-0.75]{$L_3$}%
\diode[labeloffset=-0.75]{$D_3$}.
\wire(6.5,6)(9,6)\qdisk(9,6){2pt}
\diode(9,0)(9,6){$D_4$}
\wire[intensity,intensitylabel=$i_4$](9,3.25)(9,6)
\wire[intensity,intensitylabel=$i_a$](9,6)(11,6)
\multidipole(11,6)(11,0)%
\resistor{$R_L$}
\coil[dipolestyle=rectangle]{$L_L$}
\circledipole[labeloffset=0,tension,tensionoffset=0.7,tensionlabel=$U_B$]{\LARGE\
textbf{=}}.
\wire(0,0)(11,0)\qdisk(9,0){2pt}
\pnode(12.5,5.5){A}\pnode(12.5,0.5){B}
\tension(A)(B){$u_a$}
\end{pspicture}

```

The following example was written by Manuel Luque.

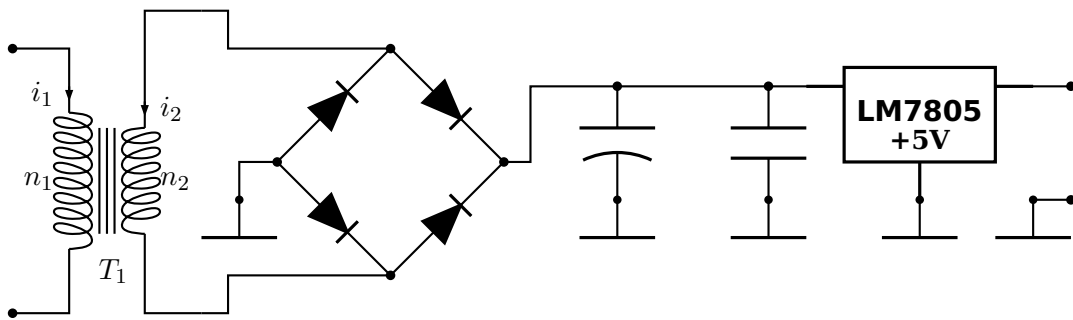

```

\begin{pspicture}(0,-0.5)(14,4)
  \pnodes(0,-0.50){B}(0,3){A}(2.5,3.5){C}(2.5,-0.5){D}(5,3){E}(6.5,1.5){F}(5,0){G}%
    (3.5,1.5){H}(8,2.5){I}(8,1){J}(10,2.5){K}(10,1){L}(14,2.5){M}(12,1){N}%
    (3,1){H'}(14,2.5){O}(14,1){P}(13.5,1){Q}
  \transformer[transformerprimarylabel=$i_1$,transformersecondarylabel=$i_2$,
    primarylabel=$n_1$,secondarylabel=$n_2$](A)(B)(C)(D){$T_1$}
  {\psset{fillstyle=solid,fillcolor=black}
  \diode(H)(E){}\diode(H)(G){}\diode(E)(F){}\diode(G)(F){}}
  \capacitor[dipolestyle=chemical](I)(J){}\capacitor(K)(L){}
  \REG(K)(M)(N){\shortstack{\textsf{\textbf{\large LM7805}}}\textbf{+5V}}
  \ncangle{I}{F}\psline(I)(K)\ncangle{E}{C}\ncangle{G}{D}
  \ncangle[arm=0]{P}{Q}\ncangle[arm=0]{H}{H'}
  \ground(H')\ground(J)\ground(L)\ground(N)\ground(Q)
  \psdots(A)(B)(P)(O)(G)(H)(F)(I)(K)(E)
\end{pspicture}

```

The following example was written by Lionel Cordesses.

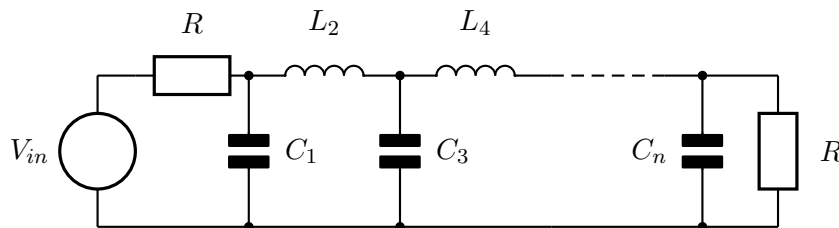

```

\begin{pspicture}(11,3)
  \psset{dipolestyle=elektor}
  \pnodes(1,2){Vin}(0.5,2){S}(0.5,0){Sm}(2.5,2){A}(4.5,2){B}(6.5,2){C}(8,2){Cd}%
    (8.5,2){D}(9.5,2){E}(2.5,0){Am}(4.5,0){Bm}(6.5,0){Cm}(8.5,0){Dm}(9.5,0){Em}
  \Ucc[labeloffset=0.9](Sm)(S){$V_{in}$}\resistor(Vin)(A){$R$}
  \capacitor(A)(Am){$C_1$}\capacitor(B)(Bm){$C_3$}
  \capacitor[labeloffset=-0.7](D)(Dm){$C_n$}\resistor(E)(Em){$R$}
  \coil(A)(B){$L_2$}\coil(B)(C){$L_4$}
  \wire(Am)(Bm)\wire(Bm)(Cm)\wire(Cm)(Dm)\wire(Dm)(Em)\wire(D)(E)
  \wire(Cd)(D)\psline[linestyle=dashed](C)(Cd)
  \wire(S)(Vin)\wire(Sm)(Am)
  \psdots(D)(Dm)(A)(Am)(B)(Bm)
\end{pspicture}

```

The following example was written by Christian Hoffmann.

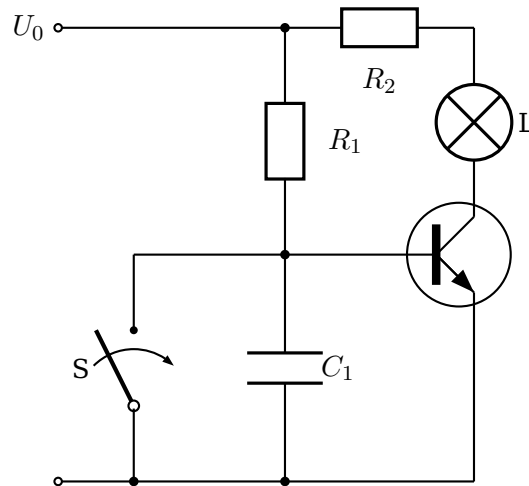

```

\SpecialCoor
\begin{pspicture}(0,-1)(7,6.5)%
\pnodes(0,6){plus}(3,3){basis}([nodesep=-2] basis){schalter}(0,0){masse}
\wire[arrows=o-*](plus)(basis|plus)
\uput[l](plus){$U_0$}
\resistor[labeloffset=.8](basis|plus)(basis){$R_1$}
\transistor[basesep=2cm](basis){emitter}{kollektor}
\wire[arrows=-*](schalter)(basis)
% \wire(basis)([nodesep=2] basis)
\wire(TBaseNode)(basis)
\switch(schalter|masse)(schalter){S}
\lamp(kollektor|plus)(kollektor){L}
\resistor(kollektor|plus)(basis|plus){$R_2$}
\wire(emitter)(emitter|masse)
\wire(emitter|masse)(basis|masse)
\capacitor(basis)(basis|masse){$C_1$}
\wire[arrows=*-](basis|masse)(schalter|masse)
\wire[arrows=*-o](schalter|masse)(masse)
\end{pspicture}

```

Variable radius for

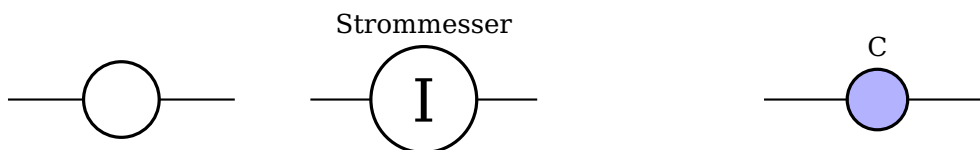

```

\begin{pspicture}(\linewidth,3)
\circledipole(0,1)(3,1){} \pnodes(4,1){A}(7,1){B}
\circledipole[radius=7mm,labeloffset=1cm](A)(B){Strommesser}\rput(5.5,1){\Huge I}
\circledipole[radius=4mm,fillstyle=solid,fillcolor=blue!30](10,1)(13,1){C}
\end{pspicture}

```

4 Microwave symbols

Since for microwave signal, the direction in which the signal spreads is very important, There are dipoleinput or tripoleinput or quadripoleinput and arrowinput parameters. The value of these parameters are left or right for the first one and true or false for second one.

```
\ifPst@inputarrow
\ifx\psk@Dinput\pst@Dinput@right
\pcline[arrows=-C](#2)(dipole@1)
\pcline[arrows=->,arrowinset=0](#3)(dipole@2)
\else
\pcline[arrows=->,arrowinset=0](#2)(dipole@1)
\pcline[arrows=C-](dipole@2)(#3)
\fi
\else
\pcline[arrows=-C](#2)(dipole@1)
\pcline[arrows=C-](dipole@2)(#3)
\fi
\pcline[fillstyle=none,linestyle=none](#2)(#3)
```

The last line is to correct some problems when I use colors (see example2) To add color in components (Monopole, tripole and Quadripole), there is a new argument. `\multidipole` also works:

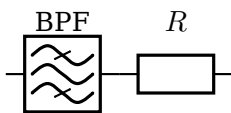

```
\begin{pspicture}(4,2)
\pnodes(0.5,1){A}(3.5,1){B}
\multidipole(A)(B)\filter{BPF}%
\resistor{R$}.
\end{pspicture}
```

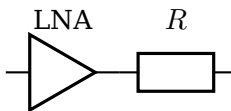

```
\begin{pspicture}(4,2)
\pnodes(0.5,1){A}(3.5,1){B}
\multidipole(A)(B)\amplifier{LNA}%
\resistor{R$}.
\end{pspicture}
```

4.1 New monopole components

New ground

`groundstyle: ads | old | triangle`

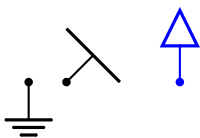

```
\begin{pspicture}(3,2)
\pnodes(0.5,1){A}(1,1){B}(2.5,1){C}
\newground(A)
\newground[groundstyle=old]{135}(B)
\newground[linecolor=blue,groundstyle=triangle]{180}(C)
\end{pspicture}
```

Antenna

`antennastyle: two | three | triangle`



```
\begin{pspicture}(3,2)
  \pnode(1,0.5){A}
  \antenna[antennastyle=three](A)
\end{pspicture}
```



```
\begin{pspicture}(3,2)
  \pnode(1,0.5){A}
  \antenna(A)
\end{pspicture}
```



```
\begin{pspicture}(3,2)
  \pnode(1,0.5){A}
  \antenna[antennastyle=triangle](A)
\end{pspicture}
```

4.2 New monopole macro-components

Oscillator

output: top | right | bottom | left

inputarrow: false | true

L0style: - | crystal

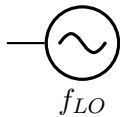

```
\begin{pspicture}(3,2)
  \pnode(1,1){A}
  \oscillator[output=left,inputarrow=false](A)%
  {$f_{LO}$}{}
\end{pspicture}
```

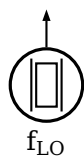

```
\begin{pspicture}(3,2)
  \pnode(1,1){A}
  \oscillator[output=top,inputarrow=true,L0style=crystal](A)%
  {$f_{\text{trm}{LO}}$}{}
\end{pspicture}
```

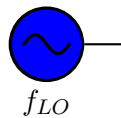

```
\begin{pspicture}(3,2)
  \pnode(1,1){A}
  \oscillator[output=right,inputarrow=false](A)%
  {$f_{LO}$}{fillstyle=solid,fillcolor=blue}
\end{pspicture}
```



```
\begin{pspicture}(3,2)
  \pnode(1,1){A}
  \oscillator[output=bottom,inputarrow=false](A)%
  {$f_{LO}$}{}
\end{pspicture}
```

4.3 New dipole macro-components

Filters

dipolestyle: bandpass | lowpass | highpass

inputarrow: false | true

dipoleinput: left | right

	<pre>\begin{pspicture}(3,2) \node(0,1){A} \node(3,1){B} \filter(A)(B){BPF} \end{pspicture}</pre>
	<pre>\begin{pspicture}(3,2) \node(0,1){A} \node(3,1){B} \filter[dipolestyle=lowpass,fillstyle=solid,% fillcolor=red](A)(B){LPF} \end{pspicture}</pre>
	<pre>\begin{pspicture}(3,2) \node(0,1){A} \node(3,1){B} \filter[dipolestyle=highpass,dipoleinput=right, inputarrow=true](A)(B){HPF} \end{pspicture}</pre>
	<pre>\begin{pspicture}(3,2) \node(0,1){A} \node(3,1){B} \filter[dipolestyle=highpass,inputarrow=true](A)(B){BPF} \end{pspicture}</pre>

Isolator

inputarrow: false| true

dipoleinput: left | right

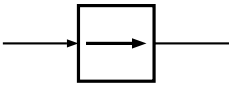
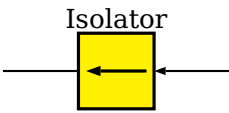
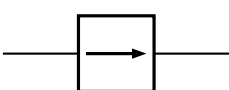
	<pre>\begin{pspicture}(3,2) \node(0,1){A} \node(3,1){B} \isolator[inputarrow=true](A)(B){} \end{pspicture}</pre>
	<pre>\begin{pspicture}(3,2) \node(0,1){A} \node(3,1){B} \isolator[dipoleinput=right,inputarrow=true, fillstyle=solid,fillcolor=yellow](A)(B){Isolator} \end{pspicture}</pre>
	<pre>\begin{pspicture}(3,2) \node(0,1){A}\node(3,1){B} \isolator[dipoleinput=left](A)(B){} \end{pspicture}</pre>

Frequency multiplier/divider

dipolestyle: multiplier | divider

value: N | $n \in \mathbb{N}$

programmable: false| true

inputarrow: false| true

dipoleinput: left | right

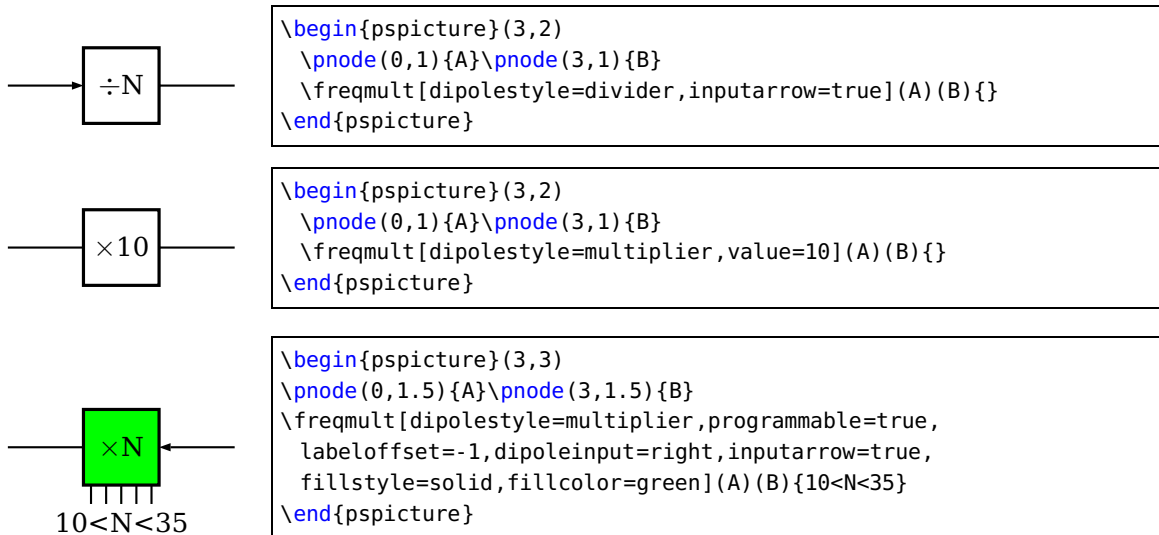

Phase shifter

inputarrow: false| true

dipoleinput: left | right

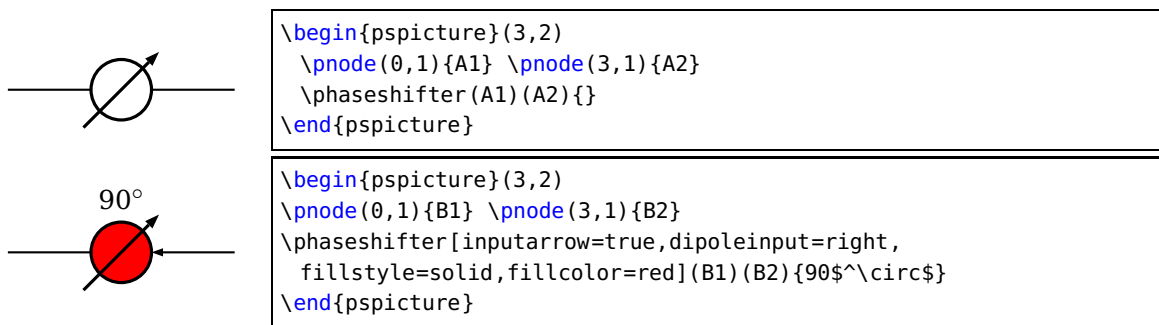

VCO

inputarrow: false| true

dipoleinput: left | right

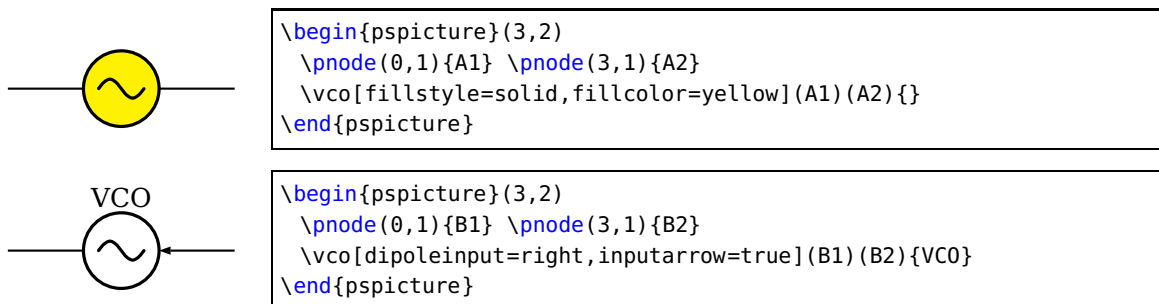

Amplifier

inputarrow: false| true

dipoleinput: left | right

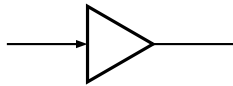

```
\begin{pspicture}(3,2)
 \pnode(0,1){A} \pnode(3,1){B}
 \amplifier[inputarrow=true](A)(B){}
 \end{pspicture}
```

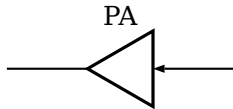

```
\begin{pspicture}(3,2)
 \pnode(0,1){A} \pnode(3,1){B}
 \amplifier[dipoleinput=right,inputarrow=true](A)(B){PA}
 \end{pspicture}
```

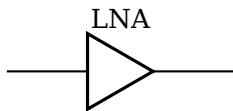

```
\begin{pspicture}(3,2)
 \pnode(0,1){A} \pnode(3,1){B}
 \amplifier[dipoleinput=left](A)(B){LNA}
 \end{pspicture}
```

Detector

inputarrow: false | true

dipoleinput: left | right

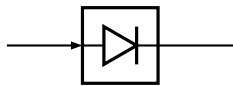

```
\begin{pspicture}(3,2)
 \pnode(0,1){A} \pnode(3,1){B}
 \detector[inputarrow=true](A)(B){}
 \end{pspicture}
```

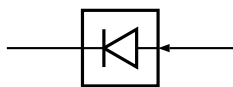

```
\begin{pspicture}(3,2)
 \pnode(0,1){A} \pnode(3,1){B}
 \detector[dipoleinput=right,inputarrow=true](A)(B){}
 \end{pspicture}
```

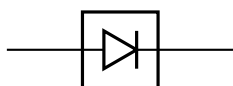

```
\begin{pspicture}(3,2)
 \pnode(0,1){A} \pnode(3,1){B}
 \detector[dipoleinput=left](A)(B){}
 \end{pspicture}
```

Attenuator

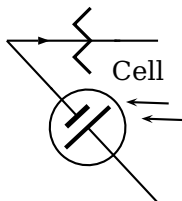

```
\begin{pspicture}(3,2)
 \pnodes(0,0){A}(2,0){B}
 \attenuator[inputarrow,labeloffset=1cm,
 dipoleinput=left](A)(B){Attenuator}
 \end{pspicture}
```

```
\begin{pspicture}(3,2)
 \pnodes(0,0){AA}(2,0){B}
 \cell[labeloffset=1cm](A)(B){Cell}
 \end{pspicture}
```

4.4 New tripole macro-components

Mixer

tripolestyle: bottom | top

tripoleconfig: left | right

inputarrow: false | true

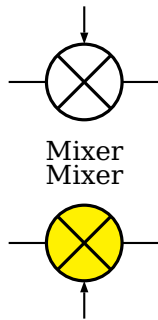

```
\begin{pspicture}(3,2)
  \pnode(0.5,1){A}\pnode(2.5,1){B}\pnode(1.5,2){C}
  \mixer[tripolestyle=top,inputarrow=true](A)(B)(C)%
  {Mixer}{}
\end{pspicture}
```

```
\begin{pspicture}(3,2)
  \pnode(0.5,1){A}\pnode(2.5,1){B}\pnode(1.5,0){C}
  \mixer[inputarrow=true,tripoleinput=right](A)(B)(C)
  {Mixer}{fillstyle=solid,fillcolor=yellow}
\end{pspicture}
```

Circulator

tripolestyle: circulator | isolator

inputarrow: false | true

tripoleinput: left | right

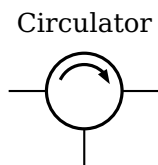

```
\begin{pspicture}(3,2)
  \pnode(0.5,1){A}\pnode(2.5,1){B}\pnode(1.5,0){C}
  \circulator{0}(A)(B)(C){Circulator}{}
\end{pspicture}
```

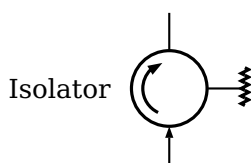

```
\begin{pspicture}(3,3)
  \pnode(1.5,0.5){A}\pnode(1.5,2.5){B}\pnode(0.5,1.5){C}
  \circulator[tripolestyle=isolator,inputarrow=true]{90}%
  (A)(B)(C){Isolator}{}
\end{pspicture}
```

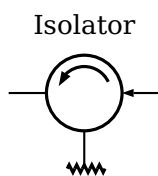

```
\begin{pspicture}(3,2)
  \pnode(0.5,1){A}\pnode(2.5,1){B}\pnode(1.5,0){C}
  \circulator[tripoleconfig=right,tripolestyle=isolator,
  inputarrow=true,tripoleinput=right]{0}%
  (B)(A)(C){Isolator}{}
\end{pspicture}
```

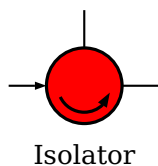

```
\begin{pspicture}(3,2)
  \pnode(0.5,1){A}\pnode(2.5,1){B}\pnode(1.5,2){C}
  \circulator[tripoleconfig=right,
  inputarrow=true]{180}(A)(B)(C){Isolator}%
  {fillstyle=solid,fillcolor=red}
\end{pspicture}
```

Agc

inputarrow: false | true

tripoleinput: left | right

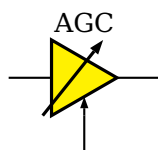

```
\begin{pspicture}(3,2)
  \pnode(0.5,1){A}\pnode(2.5,1){B}\pnode(1.5,0){C}
  \agc(A)(B)(C){AGC}{fillstyle=solid,fillcolor=yellow}
\end{pspicture}
```

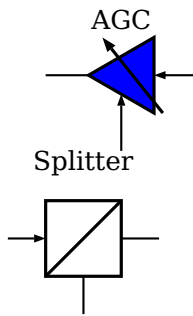
```
\begin{pspicture}(3,2)
 \pnode(0.5,1){A}\pnode(2.5,1){B}\pnode(1.5,0){C}
 \agc[tripoleinput=right,inputarrow=true](A)(B)(C)%
 {AGC}{fillstyle=solid,fillcolor=blue}
\end{pspicture}
```

```
\begin{pspicture}(3,2)
 \pnodes(0,1){A}(2,1){B}(1,0){C}
 \splitter[inputarrow,labeloffset=1cm,
 tripolestyle=bottom](A)(B)(C){Splitter}{}
\end{pspicture}
```

4.5 New quadrupole macro-components

Coupler

couplerstyle: hybrid | directional

inputarrow: false | true

quadrupoleinput: left | right

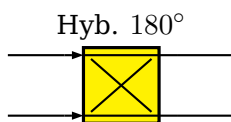

```
\begin{pspicture}(3,2)
 \pnode(0,1.4){A} \pnode(0,0.6){B}
 \pnode(3,1.4){C} \pnode(3,0.6){D}
 \coupler[couplerstyle=hybrid,inputarrow=true](A)(B)(C)(D)%
 {Hyb. $180^\circ$}{fillstyle=solid,fillcolor=yellow}
\end{pspicture}
```

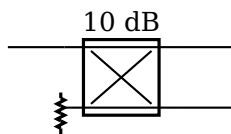

```
\begin{pspicture}(3,2)
 \pnode(0,1.4){A} \pnode(0,0.6){B}
 \pnode(3,1.4){C} \pnode(3,0.6){D}
 \coupler[couplerstyle=directional](A)(B)(C)(D){10~dB}{}
\end{pspicture}
```

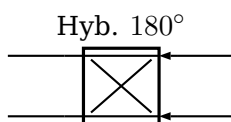

```
\begin{pspicture}(3,2)
 \pnode(0,1.4){A} \pnode(0,0.6){B}
 \pnode(3,1.4){C} \pnode(3,0.6){D}
 \coupler[couplerstyle=hybrid,inputarrow=true,%
 quadrupoleinput=right](A)(B)(C)(D)%
 {Hyb. $180^\circ$}{}
\end{pspicture}
```

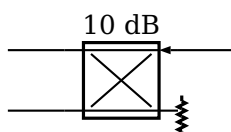

```
\begin{pspicture}(3,2)
 \pnode(0,1.4){A} \pnode(0,0.6){B}
 \pnode(3,1.4){C} \pnode(3,0.6){D}
 \coupler[couplerstyle=directional,quadrupoleinput=right,%
 inputarrow=true](A)(B)(C)(D){10~dB}{}
\end{pspicture}
```

4.6 Examples

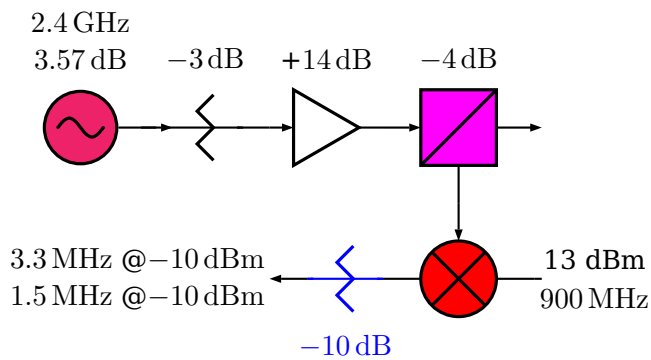

Radiometer block diagram example

From Chang, K., RF and Microwave Wireless Systems, Wiley InterScience, page 319, ISBN 0-471-35199-7

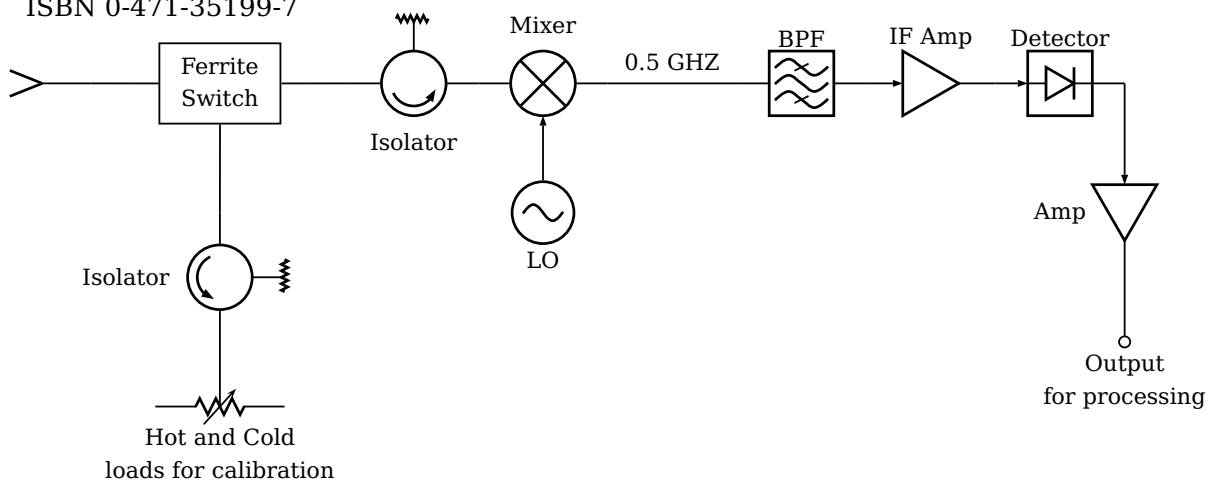

Ku-band Transceiver

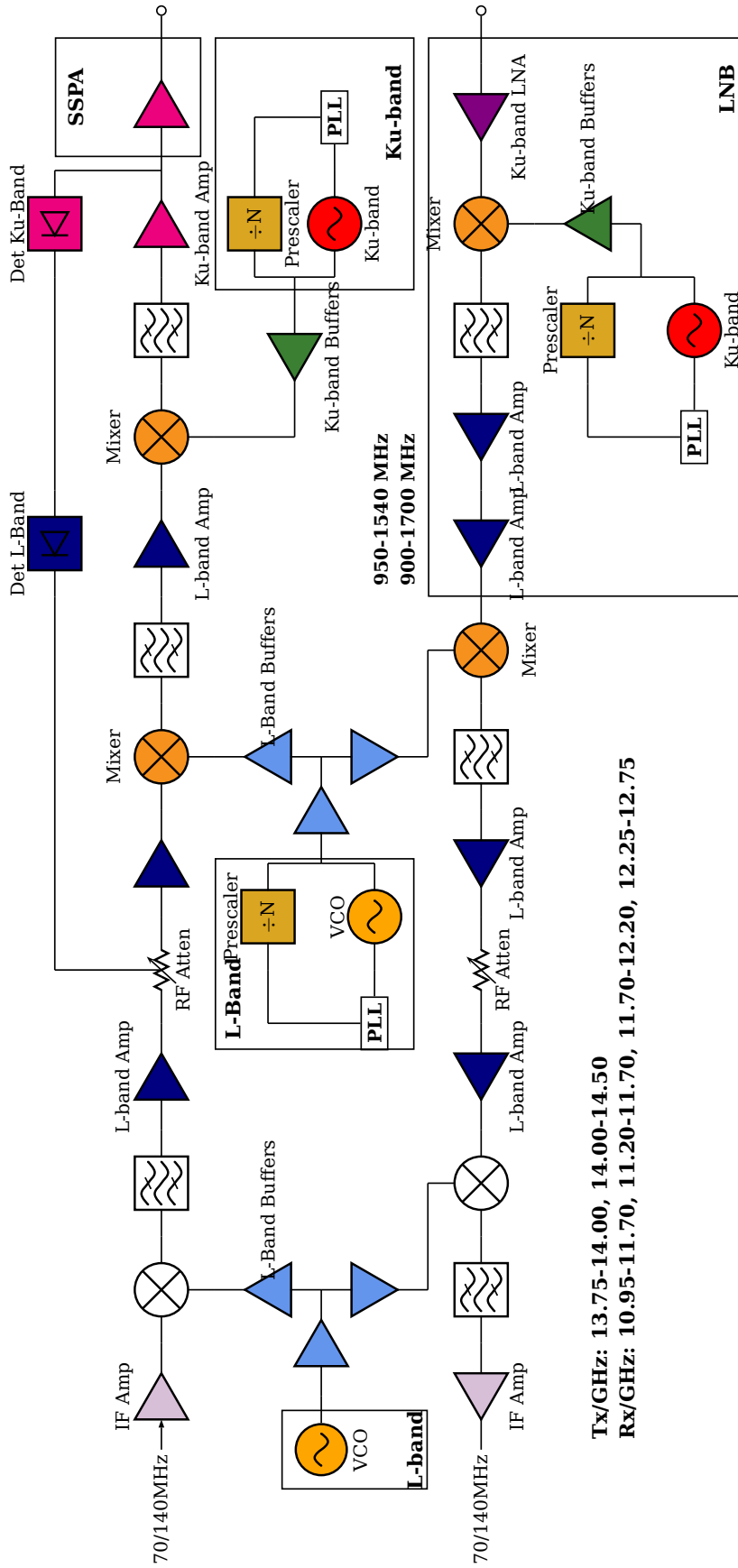

Tx/GHz: 13.75-14.00, 14.00-14.50
Rx/GHz: 10.95-11.70, 11.20-11.70, 11.70-12.20, 12.25-12.75

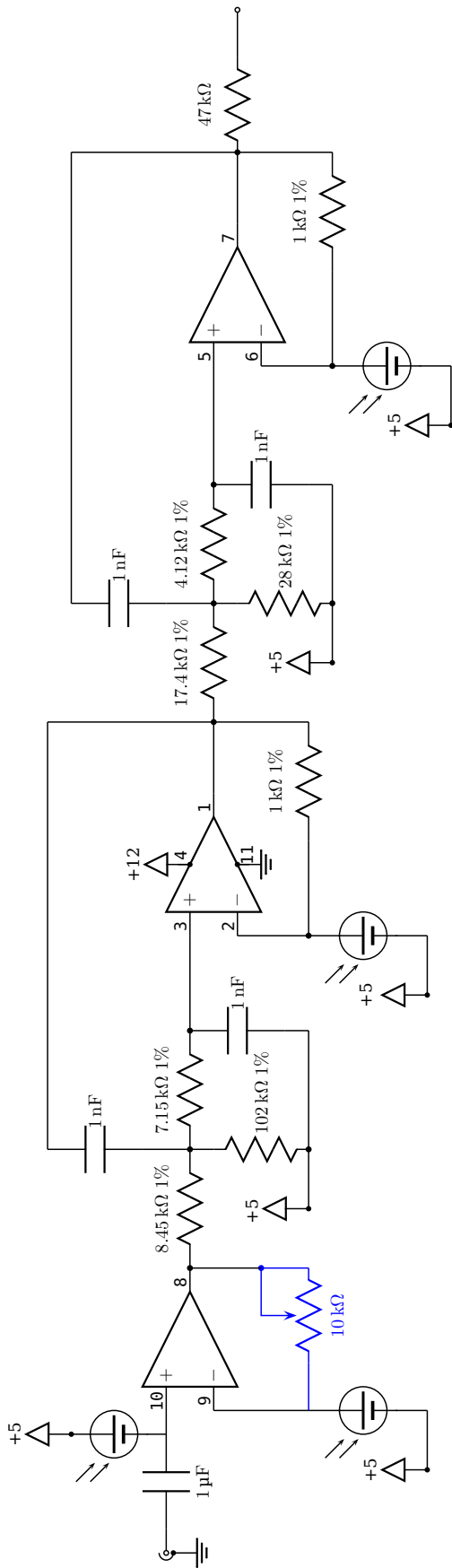

5 Flip Flops – logical elements

The syntax for all logical base circuits is

```
\logic [Options] (x0, y0) {label}
```

where the options and the origin are optional. If they are missing, then the default options, described in the next section and the default origin (0,0) is used. The origin specifies the lower left corner of the logical circuit.

xLkeywordlogicType

```
\logic{Demo}
\logic[logicType=and]{Demo}
\logic(0,0){Demo}
\logic[logicType=and](0,0){Demo}
```

The above four „different“ calls of the `\logic` macro give the same output, because they are equivalent.

5.1 The Options

<i>name</i>	<i>type</i>	<i>default</i>
<code>logicShowNode</code>	boolean	false
<code>logicShowDot</code>	boolean	false
<code>logicNodestyle</code>	command	<code>\footnotesize</code>
<code>logicSymbolstyle</code>	command	<code>\large</code>
<code>logicSymbolpos</code>	value	0.5
<code>logicLabelstyle</code>	command	<code>\small</code>
<code>logicType</code>	string	and
<code>logicChangeLR</code>	boolean	false
<code>logicWidth</code>	length	1.5
<code>logicHeight</code>	length	2.5
<code>logicWireLength</code>	length	0.5
<code>logicNInput</code>	number	2
<code>logicJInput</code>	number	2
<code>logicKInput</code>	number	2

5.2 Basic Logical Circuits

At least the basic objects require a unique label name, otherwise it is not sure, that all nodes will work well. The label may contain any alphanumerical character and most of all symbols. But it is save using only combinations of letters and digits. For example:

```
And0
a0
a123
12
NOT123a
```

A_1 is not a good choice, the underscore may cause some problems.

And

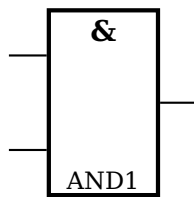

```
\begin{pspicture}(-1,0)(3,3)
\logic{AND1}
\end{pspicture}
```

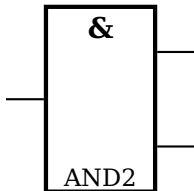

```
\begin{pspicture}(-0.5,0)(3,3)
\logic[logicChangeLR]{AND2}
\end{pspicture}
```

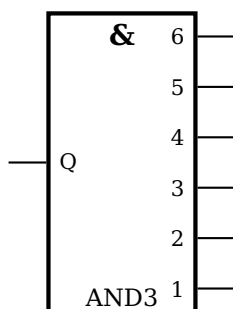

```
\begin{pspicture}(-0.5,0)(4,5)
\logic[logicShowNode,%
  logicWidth=2,
  logicHeight=4,
  logicNInput=6,
  logicChangeLR](1,1){AND3}
\end{pspicture}
```

NotAnd

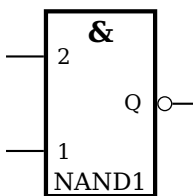

```
\begin{pspicture}(-0.5,0)(3,3)
\logic[logicType=nand,
  logicShowNode]{NAND1}
\end{pspicture}
```

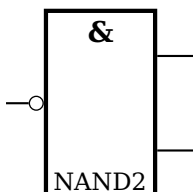

```
\begin{pspicture}(-0.5,0)(3,3)
\logic[logicType=nand,
  logicChangeLR]{NAND2}
\end{pspicture}
```

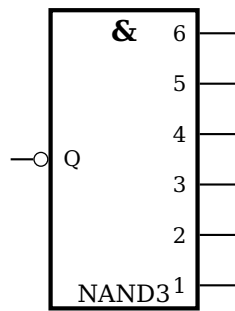

```
\begin{pspicture}(4,5)
\logic[logicType=nand,
  logicShowNode,
  logicWidth=2,
  logicHeight=4,
  logicNInput=6,
  logicChangeLR](1,1){NAND3}
\end{pspicture}
```

Or

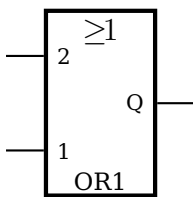

```
\begin{pspicture}(-0.5,0)(3,3)
\logic[logicType=or,
  logicShowNode]{OR1}
\end{pspicture}
```

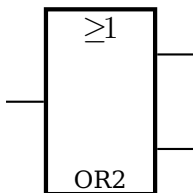

```
\begin{pspicture}(-0.5,0)(3,3)
\logic[logicType=or,
  logicChangeLR]{OR2}
\end{pspicture}
```

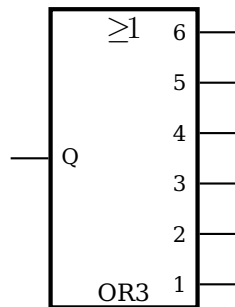

```
\begin{pspicture}(4,5)
\logic[logicType=or,
  logicShowNode,
  logicWidth=2,
  logicHeight=4,
  logicNInput=6,
  logicChangeLR](1,1){OR3}
\end{pspicture}
```

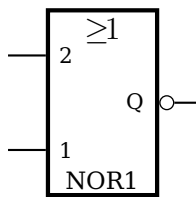
Not Or

```
\begin{pspicture}(-0.5,0)(3,3)
\logic[logicType=nor,
  logicShowNode]{NOR1}
\end{pspicture}
```

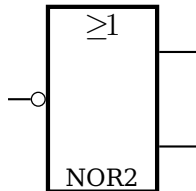

```
\begin{pspicture}(-0.5,0)(3,3)
\logic[logicType=nor,
  logicChangeLR]{NOR2}
\end{pspicture}
```

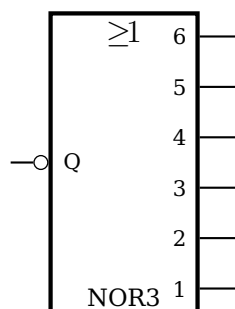

```
\begin{pspicture}(4,5)
\logic[logicType=nor,
  logicShowNode,
  logicWidth=2,
  logicHeight=4,
  logicNInput=6,
  logicChangeLR](1,1){NOR3}
\end{pspicture}
```

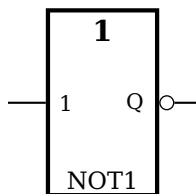
Not

```
\begin{pspicture}(-0.5,0)(3,3)
\logic[logicType=not,
  logicShowNode]{NOT1}
\end{pspicture}
```

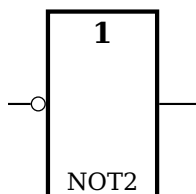

```
\begin{pspicture}(-0.5,0)(3,3)
\logic[logicType=not,
  logicChangeLR]{NOT2}
\end{pspicture}
```

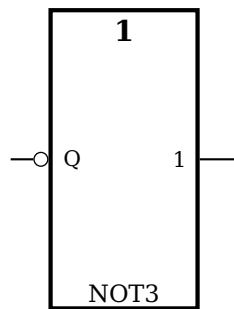

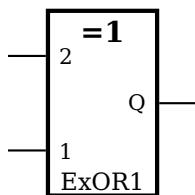

```
\begin{pspicture}(4,5)
\logic[logicType=not,
  logicShowNode,
  logicWidth=2,
  logicHeight=4,
  logicChangeLR](1,1){NOT3}
\end{pspicture}
```

Exclusive OR

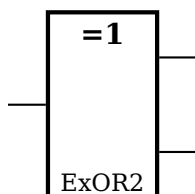

```
\begin{pspicture}(-0.5,0)(3,3)
\logic[logicType=exor,
  logicShowNode]{ExOR1}
\end{pspicture}
```



```
\begin{pspicture}(-0.5,0)(3,3)
\logic[logicType=exor,
  logicChangeLR]{ExOR2}
\end{pspicture}
```

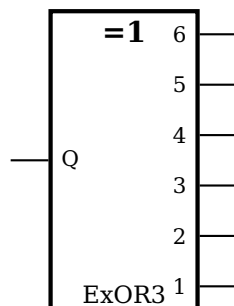

```
\begin{pspicture}(4,5)
\logic[logicType=exor,
  logicShowNode,
  logicNInput=6,
  logicWidth=2,
  logicHeight=4,
  logicChangeLR](1,1){ExOR3}
\end{pspicture}
```

Exclusive NOR

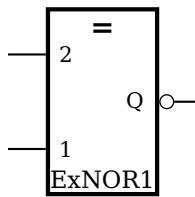

```
\begin{pspicture}(-0.5,0)(3,3)
\logic[logicType=exnor,
  logicShowNode]{ExNOR1}
\end{pspicture}
```

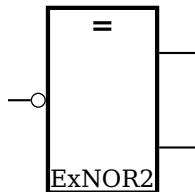

```
\begin{pspicture}(-0.5,0)(3,3)
\logic[logicType=exnor,
  logicChangeLR]{ExNOR2}
\end{pspicture}
```

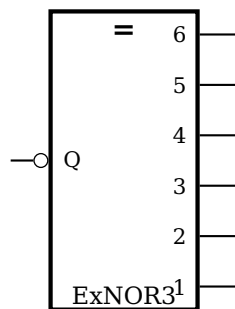

```
\begin{pspicture}(4,5)
\logic[logicType=exnor,
  logicShowNode,
  logicNInput=6,
  logicWidth=2,
  logicHeight=4,
  logicChangeLR](1,1){ExNOR3}
\end{pspicture}
```

5.3 RS Flip Flop

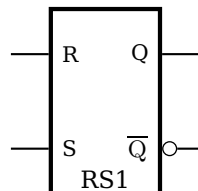

```
\begin{pspicture}(-1,-1)(3,3)
\logic[logicShowNode,
  logicType=RS]{RS1}
\end{pspicture}
```

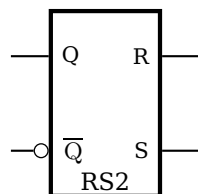

```
\begin{pspicture}(-1,-1)(3,3)
\logic[logicShowNode,
  logicType=RS,
  logicChangeLR]{RS2}
\end{pspicture}
```

5.4 D Flip Flop

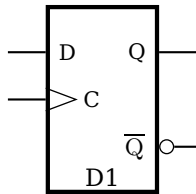

```
\begin{pspicture}(-1,-1)(3,3)
\logic[logicShowNode,
logicType=D]{D1}
\end{pspicture}
```

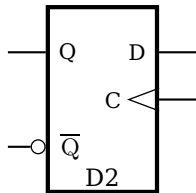

```
\begin{pspicture}(-1,-1)(3,3)
\logic[logicShowNode=true,
logicType=D,
logicChangeLR]{D2}
\end{pspicture}
```

5.5 JK Flip Flop

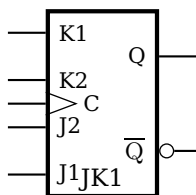

```
\begin{pspicture}(-1,-1)(3,3)
\logic[logicShowNode,
logicType=JK,
logicKInput=2,
logicJInput=2]{JK1}
\end{pspicture}
```

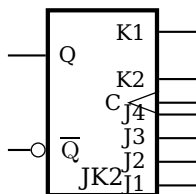

```
\begin{pspicture}(-1,-1)(3,3)
\logic[logicShowNode,logicType=JK,
logicKInput=2,logicJInput=4,
logicChangeLR]{JK2}
\end{pspicture}
```

5.6 Other Options

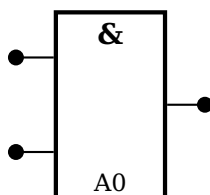

```
\begin{pspicture}(-0.5,0)(3,2.5)
\logic[logicShowDot]{A0}
\end{pspicture}
```

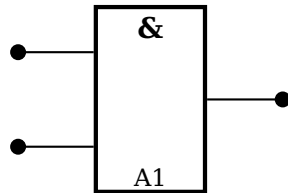

```
\begin{pspicture}(-1,0)(3,2.5)
\logic[logicWireLength=1,
logicShowDot]{A1}
\end{pspicture}
```

The unit of `logicWireLength` is the same than the actual one for `pspicture`, set by the `unit` option.

5.7 The Node Names

Every logic circuit is defined with its name, which should be a unique one. If we have the following NAND circuit, then `pst-circ` defines the nodes

```
NAND11, NAND12, NAND13, NAND14, NAND1Q
```

If there exists an inverted output, like for all Flip Flops, then the negated one gets the appendix `neg` to the node name. For example:

```
NAND1Q, NAND1Qneg
```

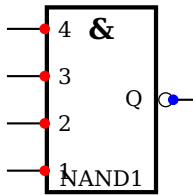

```
\begin{pspicture}(-0.5,0)(2.5,3)
\logic[logicShowNode=true,%
logicLabelstyle=\footnotesize,%
logicType=nand,%
logicNInput=4]{NAND1}
\multido{\n=1+1}{4}{%
\pscircle*[linecolor=red](NAND1\n){2pt}%
}
\pscircle*[linecolor=blue](NAND1Q){2pt}
\end{pspicture}
```

Now it is possible to draw a line from the output to the input

```
\ncbar[angleA=0,angleB=180]{<Node A>}{<Node B>}
```

It may be easier to print a grid since the drawing phase and then comment it out if all is finished.

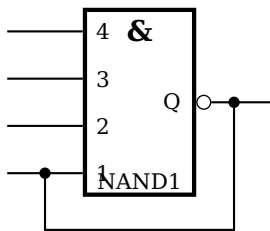

```
\begin{pspicture}(-1,-1)(2.5,3)
\logic[logicShowNode=true,%
logicLabelstyle=\footnotesize,%
logicType=nand,%
logicWireLength=1,%
logicNInput=4]{NAND1}
\pnode(-0.5,0|NAND1){tempA}
\pnode(2,0|NAND1Q){tempB}
\end{pspicture}
\ncbar[angleA=-90,angleB=0,arm=0.75,%
arrows=**,dotsize=0.15]{tempA}{tempB}
```

AN empty argument to the `logicSymbolstyle` and `logicLabelstyle` will suppress the output of the symbol and/or the label. The label, of course, is a mandatory argument because it is the prefix of the node names.

5.8 Examples

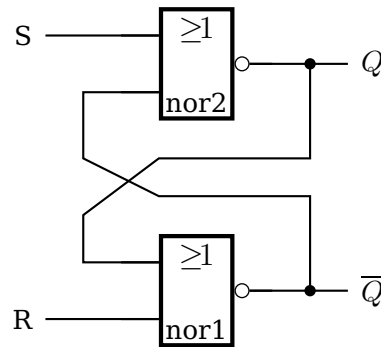

```

\begin{pspicture}(-1,0)(5,5)
  \psset{logicType=nor, logicLabelstyle=\normalsize,%
    logicWidth=1, logicHeight=1.5, dotsize=0.15}
  \logic(1.5,0){nor1}
  \logic(1.5,3){nor2}
  \psline(nor2Q)(4,0|nor2Q)
  \uput[0](4,0|nor2Q){$Q$}
  \psline(nor1Q)(4,0|nor1Q)
  \uput[0](4,0|nor1Q){$\overline{Q}$}
  \psline{*}(3.50,0|nor2Q)(3.5,2.5)(1.5,2.5)
    (0.5,1.75)(0.5,0|nor12)(nor12)
  \psline{*}(3.50,0|nor1Q)(3.5,2)(1.5,2)
    (0.5,2.5)(0.5,0|nor21)(nor21)
  \psline(0,0|nor11)(nor11)\uput[180](0,0|nor11){R}
  \psline(0,0|nor22)(nor22)\uput[180](0,0|nor22){S}
\end{pspicture}

```

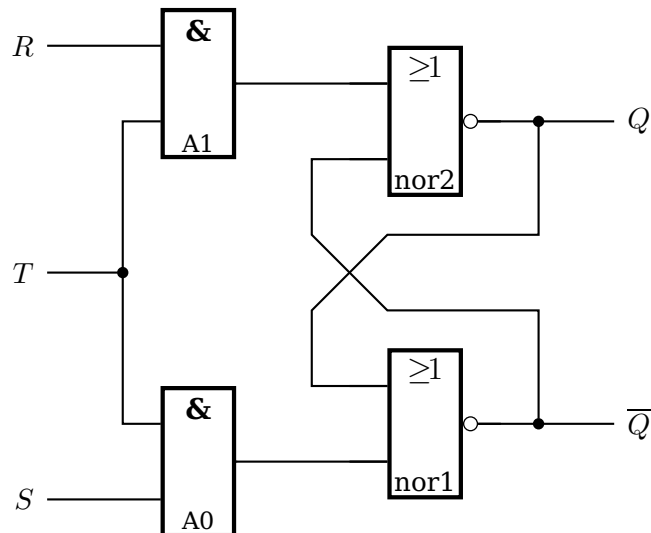

```

\begin{pspicture}(-4,0)(5,7)
  \psset{logicWidth=1, logicHeight=2, dotsize=0.15}
  \logic[logicWireLength=0](-2,0){A0}
  \logic[logicWireLength=0](-2,5){A1}
  \ncbar[angleA=-180,angleB=-180,arm=0.5]{A11}{A02}
  \psline[dotsize=0.15]{-*}(-3.5,3.5)(-2.5,3.5)
  \uput[180](-3.5,3.5){$T$}
  \psline(-3.5,0.5)(A01)\uput[180](-3.5,0.5){$S$}
  \psline(-3.5,6.5)(A12)\uput[180](-3.5,6.5){$R$}
  \psset{logicType=nor, logicLabelstyle=\normalsize}
  \logic(1,0.5){nor1}
  \logic(1,4.5){nor2}
  \psline(nor2Q)(4,0|nor2Q)
  \uput[0](4,0|nor2Q){$Q$}
  \psline(nor1Q)(4,0|nor1Q)
  \uput[0](4,0|nor1Q){$\overline{Q}$}
  \psline{*-}(3,0|nor2Q)(3,4)(1,4)(0,3)(0,0|nor12)(nor12)
  \psline{*-}(3,0|nor1Q)(3,3)(1,3)(0,4)(0,0|nor21)(nor21)
  \psline(A0Q)(nor11)
  \psline(A1Q)(nor22)
\end{pspicture}

```

6 Logical circuits in american style

<i>macro</i>	<i>option</i>	<i>defaults</i>
\logicnot	input	true
	invertinput	false
	invertoutput	false
	iec	false
	iecinvert	false
	bubblesize	0.2
	possible values	0.05, 0.10, 0.15, 0.20
\logicand	ninputs	2
	input?	true
	where ? = a-d	
	invertinput?	false
	where ? = a-d	
	invertoutput	false
	iec	false
	iecinvert	false
	bubblesize	0.2
possible values	0.05, 0.10, 0.15, 0.20	
\logicor	ninputs	2
	input?	true
	where ? = 1-4	
	invertinput?	false
	where ? = a-d	
	invertoutput	false
	iec	false
	iecinvert	false
	bubblesize	0.2
possible values	0.05, 0.10, 0.15, 0.20	
\logicxor	ninputs	2
	input?	true
	where ? = 1-4	
	invertinput?	false
	where ? = a-d	
	invertoutput	false
	iec	false
	iecinvert	false
	bubblesize	0.2
possible values	0.05, 0.10, 0.15, 0.20	
\logicff	inputa	true
	invertinputa	false

continued on next page ...

<i>macro</i>	<i>option</i>	<i>defaults</i>
	inputalabel	
	inputb	true
	invertinputb	false
	inputblabel	
	enable	false
	invertenable	false
	clock	false
	invertclock	false
	set	false
	invertset	false
	reset	false
	invertreset	false
	bubblesize	0.2
	possible values	0.05, 0.10, 0.15, 0.20
<code>\logicic</code>	nicpins	8
	possible values	8, 14, 16, 20, 32
	pin?	true
	invertpin?	false
	pin?label	
	pin?number	
	where ? =	a-z,aa,ab,ac,ad,ae,af
	bubblesize	0.2
	possible values	0.05, 0.10, 0.15, 0.20
<code>\xic</code>	plcaddress	
	plcsymbol	
<code>\xio</code>	plcaddress	
	plcsymbol	
<code>\ote</code>	plcaddress	
	plcsymbol	
	latch	false
	unlatch	false
<code>\osr</code>	plcaddress	
	plcsymbol	
<code>\res</code>	plcaddress	
	plcsymbol	
<code>\swpb</code>	contactclosed	false
<code>\swtog</code>	contactclosed	false
<code>\contact</code>	contactclosed	false

6.1 Examples

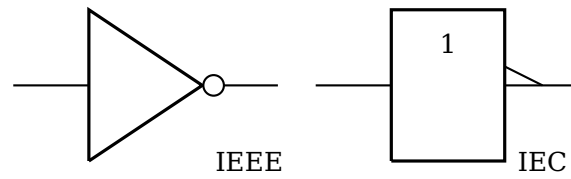

```
\begin{pspicture}(-1,-1)(8.5,3)
  \logicnot[invertoutput=true](0,0){IEEE}
  \logicnot[invertoutput=true,iec=true,iecinvert=true](4,0){IEC}
\end{pspicture}
```

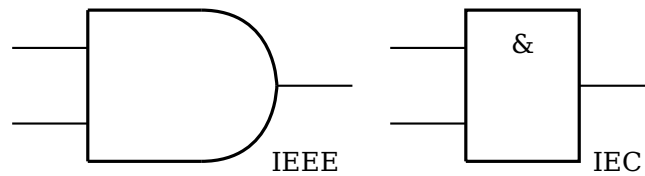

```
\begin{pspicture}(-1,-1)(9.5,3)
  \logicand[ninputs=2](0,0){IEEE}
  \logicand[ninputs=2,iec=true](5,0){IEC}
\end{pspicture}
```

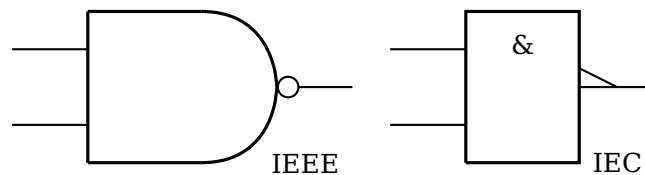

```
\begin{pspicture}(-1,-1)(9.5,3)
  \logicand[ninputs=2,invertoutput=true](0,0){IEEE}
  \logicand[ninputs=2,invertoutput=true,iec=true,iecinvert=true](5,0){IEC}
\end{pspicture}
```

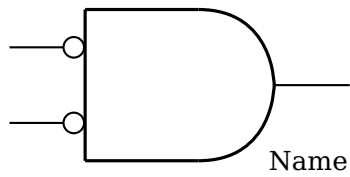

```
\begin{pspicture}(-1,-1)(5,3)
  \logicand[ninputs=2,invertinputa=true,
            invertinputb=true](0,0){Name}
\end{pspicture}
```

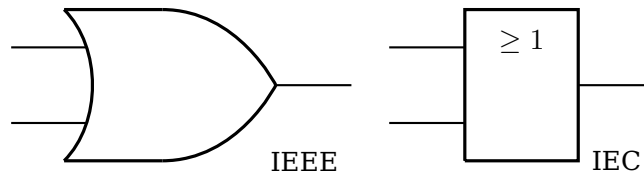

```
\begin{pspicture}(-1,-1)(9.5,3)
  \logicor[ninputs=2](0,0){IEEE}
  \logicor[ninputs=2,iec=true](5,0){IEC}
\end{pspicture}
```

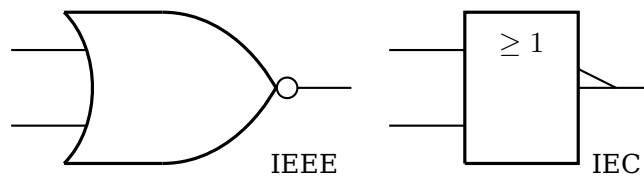

```
\begin{pspicture}(-1,-1)(9.5,3)
  \logicor[ninputs=2,invertoutput=true](0,0){IEEE}
  \logicor[ninputs=2,invertoutput=true,iec=true,iecinvert=true](5,0){IEC}
\end{pspicture}
```

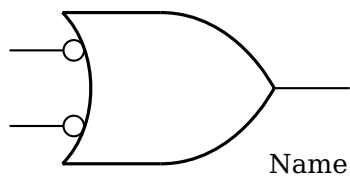

```
\begin{pspicture}(-1,-1)(5,3)
  \logicor[ninputs=2,invertinputa=true,
            invertinputb=true](0,0){Name}
\end{pspicture}
```

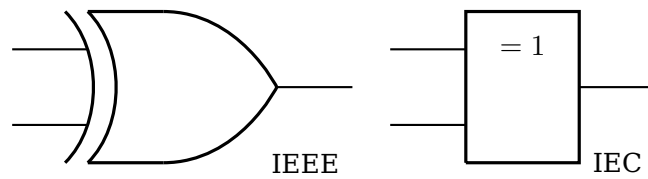

```
\begin{pspicture}(-1,-1)(9.5,3)
\logicxor[ninputs=2]{0}(0,0){IEEE}
\logicxor[ninputs=2,iec=true]{0}(5,0){IEC}
\end{pspicture}
```

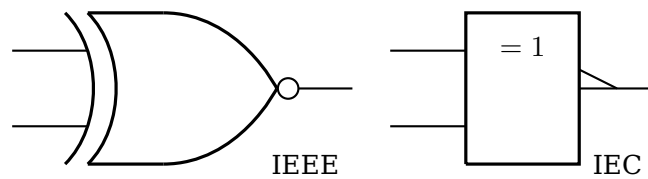

```
\begin{pspicture}(-1,-1)(9.5,3)
\logicxor[ninputs=2,invertoutput=true]{0}(0,0){IEEE}
\logicxor[ninputs=2,invertoutput=true,iec=true,iecinvert=true]{0}(5,0){IEC}
\end{pspicture}
```

S-R Flip-Flop with Clock

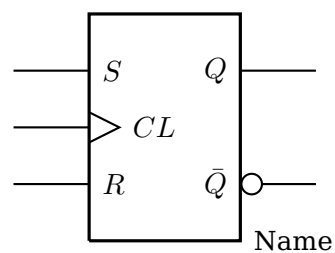

```
\begin{pspicture}(-1,-1)(5,4)
\logicff[clock=true,inputlabel=$S$,
inputlabel=$R$](0,0){Name}
\end{pspicture}
```

\bar{S} - \bar{R} Flip-Flop with Enable

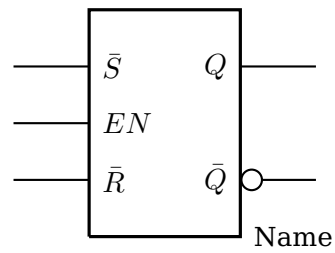

```
\begin{pspicture}(-1,-1)(5,4)
  \logicff[enable=true,inputlabel=\bar{S}
    ]$,inputlabel=\bar{R}$](0,0){Name}
\end{pspicture}
```

***J-K* Flip-Flop**

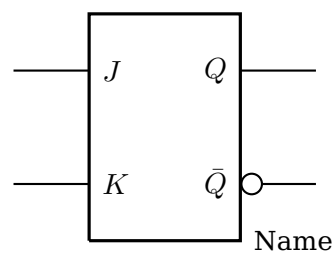

```
\begin{pspicture}(-1,-1)(5,4)
  \logicff[inputlabel=$J$,inputlabel=$K$
    ](0,0){Name}
\end{pspicture}
```

***J-K* Flip-Flop with Set and Reset**

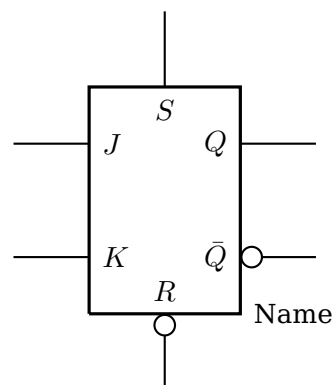

```
\begin{pspicture}(-1,-1)(5,4)
  \logicff[set=true,reset=true,invertreset=
    true,%
    inputlabel=$J$,inputlabel=$K$](0,0){
    Name}
\end{pspicture}
```

***D* Flip-Flop**

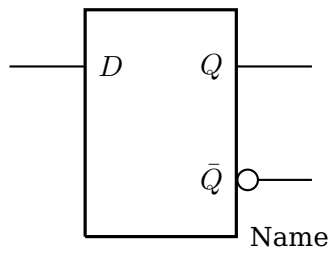

```
\begin{pspicture}(-1,-1)(5,4)
  \logicff[inputb=false,inputalabel=$D
    $(0,0){Name}
\end{pspicture}
```

Full Adder

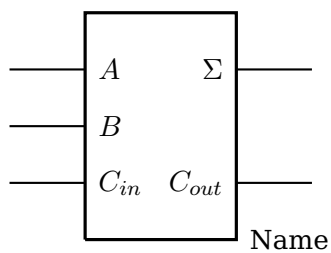

```
\begin{pspicture}(-1,-1)(5,4)
  \logicff[enable=true,invertoutputb=false,
    inputalabel=$A$,
    inputlabel=$C_{in}$,inputenlabel=$B$,
    outputalabel=$\Sigma$,
    outputlabel=$C_{out}$](0,0){Name}
\end{pspicture}
```

7-Segment Display

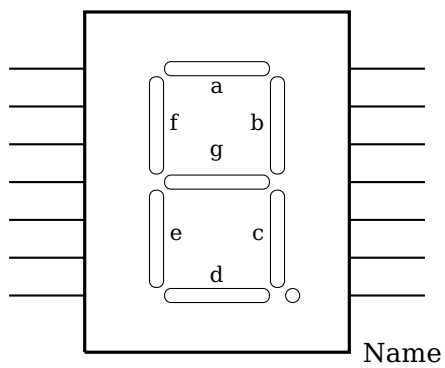

```
\begin{pspicture}(6.5,5)
  \sevensegmentdisplay(0,0){Name}
\end{pspicture}
```

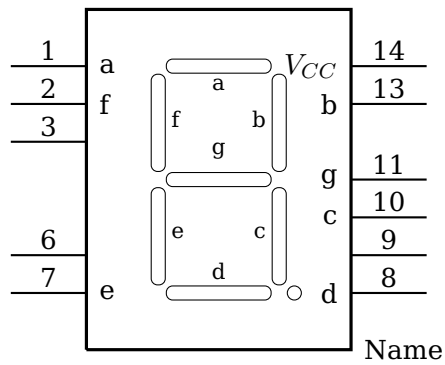

```

\begin{pspicture}(-1,-2)(6.5,6)
  \sevensegmentdisplay[pinld=false,pinle=false,pinrc=false,pinlalabel=a,
    pinlblabel=f,pinlglabel=e,pinrglabel=d,pinrelabel=c,pinrdlabel=g,
    pinrblabel=b,pinralabel={V_{CC}},pinlanumber=1,pinlbnnumber=2,
    pinlcnumber=3,pinlfnumber=6,pinlgnumber=7,pinrgnumber=8,pinrfnumber=9,
    pinrenumber=10,pinrdnumber=11,pinrnumber=13,pinranumber=14](0,0){Name}
\end{pspicture}

```

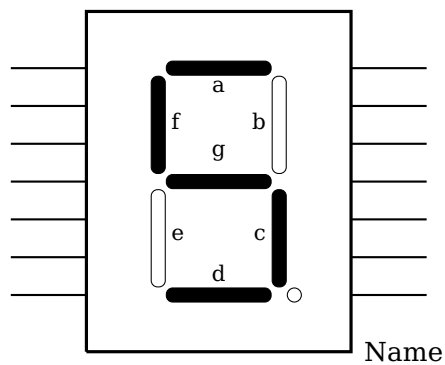

```

\begin{pspicture}(-1,-2)(6.5,6)
  \sevensegmentdisplay[segmentdisplay=5](0,0){Name}
\end{pspicture}

```

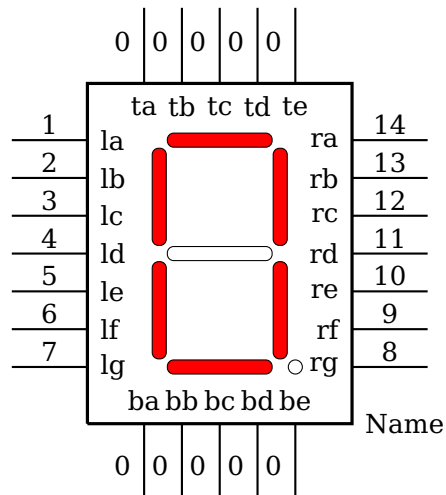

```

\begin{pspicture}(-1,-2)(6.5,6)
\sevensegmentdisplay[segmentdisplay=0,segmentcolor=red,segmentlabels=false,
pinlalabel=la,pinlblabel=lb,pinlclabel=lc,pinldlabel=ld,pinlelabel=le,
pinlflabel=lf,pinlglabel=lg,pinrglabel=rg,pinrflabel=rf,pinrelabel=re,
pinrdlabel=rd,pinrclabel=rc,pinrblabel=rb,pinralabel=ra,pinlanumber=1,
pinlbnumber=2,pinlcnumber=3,pinldnumber=4,pinlenumber=5,pinlfnumber=6,
pinlgnumber=7,pinrgnumber=8,pinrfnumber=9,pinrenumber=10,pinrdnumber=11,
pinrcnumber=12,pinrbnumber=13,pinranumber=14,pinta=true,pintalabel=ta,
pintanumber=0,pintb=true,pintblabel=tb,pintbnumber=0,pintc=true,
pintclabel=tc,pintcnumber=0,pintd=true,pintdlabel=td,pintdnumber=0,
pinte=true,pintelabel=te,pintenumber=0,pinba=true,pinbalabel=ba,
pinbanumber=0,pinbb=true,pinbblabel=bb,pinbbnumber=0,pinbc=true,
pinbclabel=bc,pinbcnumber=0,pinbd=true,pinbdlabel=bd,pinbdnumber=0,
pinbe=true,pinbelabel=be,pinbenumber=0](0,0){Name}
\end{pspicture}

```

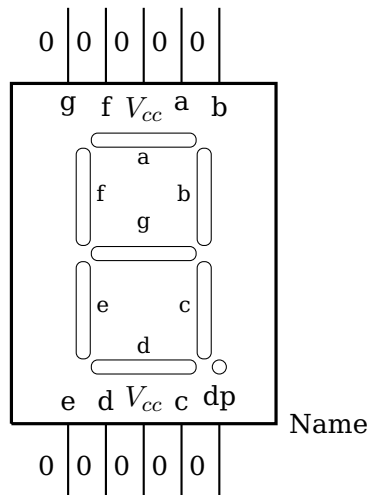

```

\begin{pspicture}(-1,-2)(6.5,6)
\sevensegmentdisplay[segmentdisplay=10,pinla=false,pinlb=false,
pinlc=false,pinld=false,pinle=false,pinlf=false,pinlg=false,pinrg=false,
pinrf=false,pinre=false,pinrd=false,pinrc=false,pinrb=false,pinra=false,
pinta=true,pintalabel=g,pintanumber=0,pintb=true,pintblabel=f,pintbnumber=0,
pintc=true,pintclabel=$V_{cc}$,pintcnumber=0,pintd=true,pintdlabel=a,
pintdnumber=0,pinte=true,pintelabel=b,pintnumber=0,pinba=true,pinbalabel=e,
pinbanumber=0,pinbb=true,pinbblabel=d,pinbbnumber=0,pinbc=true,
pinbclabel=$V_{cc}$,pinbcnumber=0,pinbd=true,pinbdlabel=c,pinbdnumber=0,
pinbe=true,pinbelabel=dp,pinbenumber=0](0,0){Name}
\end{pspicture}

```

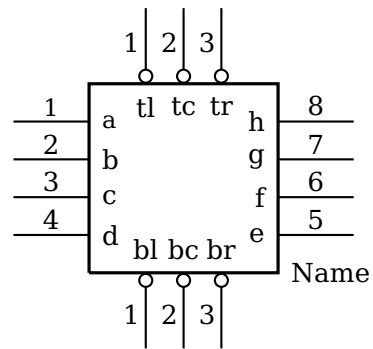

8-Pin DIP IC



```

\begin{pspicture}(-1,-2)(5,4)
\logicic[nicpins=8,bubblesize=0.1,%
 pintl=true,pintllabel=tl,pintlnumber=1,%
 pintc=true,pintclabel=tc,pintcnumber=2,%
 pintr=true,pintrlabel=tr,pintrnumber=3,%
 invertpintl=true,invertpintc=true,invertpintr=true,%
 pinbl=true,pinbllabel=bl,pinblnumber=1,%
 pinbc=true,pinbclabel=bc,pinbcnumber=2,%
 pinbr=true,pinbrlabel=br,pinbrnumber=3,%
 invertpinbl=true,invertpinbc=true,invertpinbr=true,%
 pinalabel=a,pinblabel=b,pinclabel=c,pindlabel=d,%
 pinelabel=e,pinflabel=f,pinglabel=g,pinhlabel=h,%
 pinanumber=1,pinbnumber=2,pincnumber=3,pindnumber=4,%
 pinenumber=5,pinfnumber=6,pingnumber=7,pinhnumber=8](0,0){Name}
\end{pspicture}

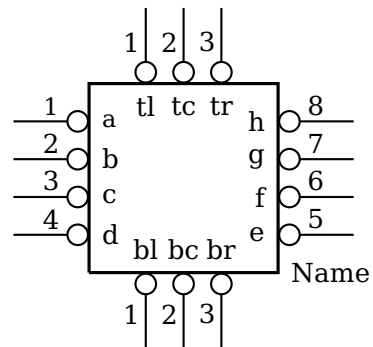
```



```

\begin{pspicture}(-1,-2)(5,4)
\logicic[nicpins=8,%
  pintl=true,pintllabel=tl,pintlnumber=1,%
  pintc=true,pintclabel=tc,pintcnumber=2,%
  pintr=true,pintrlabel=tr,pintrnumber=3,%
  invertpintl=true,invertpintc=true,invertpintr=true,%
  pinbl=true,pinbllabel=bl,pinblnumber=1,%
  pinbc=true,pinbclabel=bc,pinbcnumber=2,%
  pinbr=true,pinbrlabel=br,pinbrnumber=3,%
  invertpinbl=true,invertpinbc=true,invertpinbr=true,%
  pinalabel=a,pinblabel=b,pinclabel=c,pindlabel=d,%
  pinelabel=e,pinflabel=f,pinglabel=g,pinhlabel=h,%
  pinanumber=1,pinbnumber=2,pincnumber=3,pindnumber=4,%
  pinenumber=5,pinfnumber=6,pingnumber=7,pinhnumber=8,%
  invertpina=true,invertpinb=true,invertpinc=true,invertpind=true,%
  invertpine=true,invertpinf=true,invertping=true,invertpinh=true](0,0){Name}
\end{pspicture}

```

14-Pin DIP IC

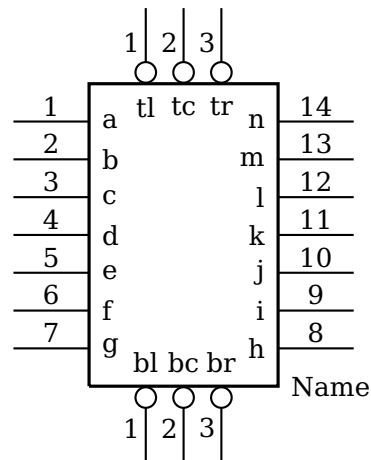

```

\begin{pspicture}(-1,-2)(5,6)
\logicic[nicpins=14,%
  pintl=true,pintllabel=tl,pintlnumber=1,%
  pintc=true,pintclabel=tc,pintcnumber=2,%
  pintr=true,pintrlabel=tr,pintrnumber=3,%
  invertpintl=true,invertpintc=true,invertpintr=true,%
  pinbl=true,pinbllabel=bl,pinblnumber=1,%
  pinbc=true,pinbclabel=bc,pinbcnumber=2,%
  pinbr=true,pinbrlabel=br,pinbrnumber=3,%
  invertpinbl=true,invertpinbc=true,invertpinbr=true,%
  pinalabel=a,pinblabel=b,pinclabel=c,pindlabel=d,%
  pinelabel=e,pinflabel=f,pinglabel=g,pinhlabel=h,%
  pinilabel=i,pinjlabel=j,pinklabel=k,pinllabel=l,%
  pinmlabel=m,pinnlabel=n,%
  pinanumber=1,pinbnumber=2,pincnumber=3,pindnumber=4,%
  pinenumber=5,pinfnumber=6,pingnumber=7,pinhnumber=8,
  pininumber=9,pinjnumber=10,pinknumber=11,pinlnumber=12,%
  pinmnumber=13,pinnnumber=14]%
(0,0){Name}
\end{pspicture}

```

14-Pin DIP IC all inverted

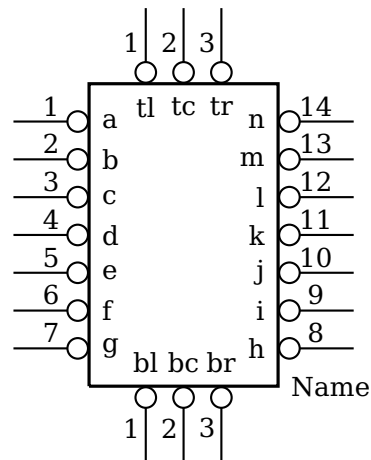

```

\begin{pspicture}(-1,-2)(5,6)
\logicic[nicpins=14,%
 pintl=true,pintllabel=tl,pintlnumber=1,%
 pintc=true,pintclabel=tc,pintcnumber=2,%
 pintr=true,pintrlabel=tr,pintrnumber=3,%
 invertpintl=true,invertpintc=true,invertpintr=true,%
 pinbl=true,pinbllabel=bl,pinblnumber=1,%
 pinbc=true,pinbclabel=bc,pinbcnumber=2,%
 pinbr=true,pinbrlabel=br,pinbrnumber=3,%
 invertpinbl=true,invertpinbc=true,invertpinbr=true,%
 pina-label=a,pinb-label=b,pinc-label=c,pind-label=d,%
 pine-label=e,pinfl-label=f,ping-label=g,pinh-label=h,%
 pinilabel=i,pinjlabel=j,pinklabel=k,pinllabel=l,%
 pinmlabel=m,pinnlabel=n,%
 pinanumber=1,pinbnumber=2,pincnumber=3,pindnumber=4,%
 pinenumber=5,pinfnumber=6,pingnumber=7,pinhnumber=8,
 pininumber=9,pinjnumber=10,pinknumber=11,pinlnumber=12,%
 pinmnumber=13,pinnnumber=14,
 invertpina=true,invertpinb=true,invertpinc=true,invertpind=true,%
 invertpine=true,invertpinf=true,invertping=true,invertpinh=true,%
 invertpini=true,invertpinj=true,invertpink=true,invertpinl=true,%
 invertpinm=true,invertpinn=true]%
(0,0){Name}
\end{pspicture}

```

16-Pin DIP IC

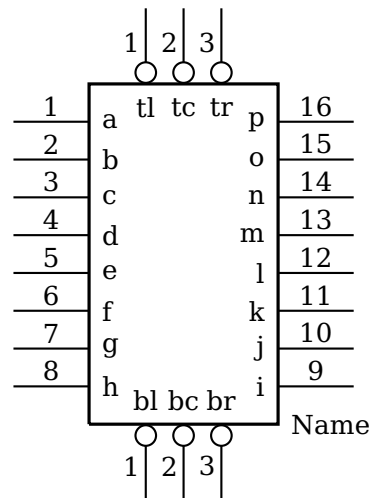

```

\begin{pspicture}(-1,-2)(5,6)
\logicic[nicpins=16,%
  pintl=true,pintllabel=tl,pintlnumber=1,%
  pintc=true,pintclabel=tc,pinctnumber=2,%
  pintr=true,pintrlabel=tr,pintrnumber=3,%
  invertpintl=true,invertpintc=true,invertpintr=true,%
  pinbl=true,pinbllabel=bl,pinblnumber=1,%
  pinbc=true,pinbclabel=bc,pinbcnumber=2,%
  pinbr=true,pinbrlabel=br,pinbrnumber=3,%
  invertpinbl=true,invertpinbc=true,invertpinbr=true,%
  pinalabel=a,pinblabel=b,pinclabel=c,pindlabel=d,%
  pinelabel=e,pinflabel=f,pinglabel=g,pinhlabeled=h,%
  pinilabel=i,pinjlabel=j,pinklabel=k,pinllabel=l,%
  pinmlabel=m,pinnlabel=n,pinolabel=o,pinplabel=p,%
  pinanumber=1,pinbnumber=2,pincnumber=3,pindnumber=4,%
  pinenumber=5,pinfnumber=6,pingnumber=7,pinhnumber=8,
  pininumber=9,pinjnumber=10,pinknumber=11,pinlnumber=12,%
  pinmnumber=13,pinnnumber=14,pinonumber=15,pinpnumber=16]%
(0,0){Name}
\end{pspicture}

```

16-Pin DIP IC all inverted

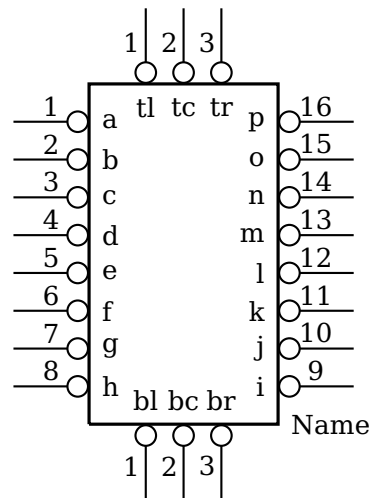

```

\begin{pspicture}(-1,-2)(5,6)
\logicic[nicpins=16,%
  pintl=true,pintllabel=tl,pintlnumber=1,%
  pintc=true,pintclabel=tc,pintcnumber=2,%
  pintr=true,pintrlabel=tr,pintrnumber=3,%
  invertpintl=true,invertpintc=true,invertpintr=true,%
  pinbl=true,pinbllabel=bl,pinblnumber=1,%
  pinbc=true,pinbclabel=bc,pinbcnumber=2,%
  pinbr=true,pinbrlabel=br,pinbrnumber=3,%
  invertpinbl=true,invertpinbc=true,invertpinbr=true,%
  pina-label=a,pinb-label=b,pinc-label=c,pind-label=d,%
  pine-label=e,pin-f-label=f,ping-label=g,pinh-label=h,%
  pin-i-label=i,pin-j-label=j,pink-label=k,pin-l-label=l,%
  pin-m-label=m,pin-n-label=n,pino-label=o,pin-p-label=p,%
  pinanumber=1,pinbnumber=2,pincnumber=3,pindnumber=4,%
  pinenumber=5,pinfnnumber=6,pingnumber=7,pinhnumber=8,
  pininumber=9,pinjnumber=10,pinknumber=11,pinlnumber=12,%
  pinmnumber=13,pinnnumber=14,pinonumber=15,pinpnumber=16,
  invertpina=true,invertpinb=true,invertpinc=true,invertpind=true,%
  invertpine=true,invertpinf=true,invertping=true,invertpinh=true,%
  invertpini=true,invertpinj=true,invertpink=true,invertpinl=true,%
  invertpinm=true,invertpinn=true,invertpino=true,invertpinp=true]%
(0,0){Name}
\end{pspicture}

```

20-Pin DIP IC

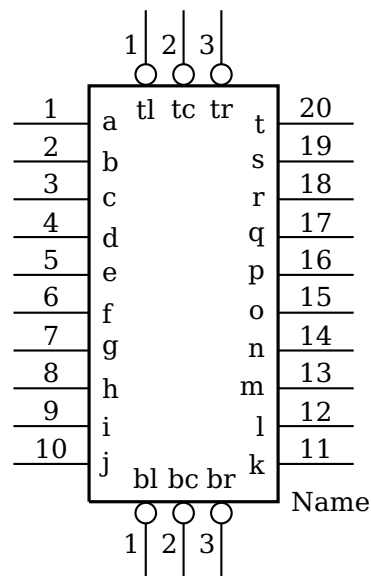

```

\begin{pspicture}(-1,-2)(5,7)
\logicic[nicpins=20,%
  pintl=true,pintllabel=tl,pintlnumber=1,%
  pintc=true,pintclabel=tc,pintcnumber=2,%
  pintr=true,pintrlabel=tr,pintrnumber=3,%
  invertpintl=true,invertpintc=true,invertpintr=true,%
  pinbl=true,pinbllabel=bl,pinblnumber=1,%
  pinbc=true,pinbclabel=bc,pinbcnumber=2,%
  pinbr=true,pinbrlabel=br,pinbrnumber=3,%
  invertpinbl=true,invertpinbc=true,invertpinbr=true,%
  pinalabel=a,pinblabel=b,pinclabel=c,pindlabel=d,%
  pinelabel=e,pinflabel=f,pinglabel=g,pinhlabeled=h,%
  pinilabel=i,pinjlabel=j,pinklabel=k,pinllabel=l,%
  pinmlabel=m,pinnlabel=n,pinolabel=o,pinplabel=p,%
  pinqlabel=q,pinrlabel=r,pinslabel=s,pintlabeled=t,%
  pinanumber=1,pinbnumber=2,pincnumber=3,pindnumber=4,%
  pinenumber=5,pinfnumber=6,pingnumber=7,pinhnumber=8,
  pininumber=9,pinjnumber=10,pinknumber=11,pinlnumber=12,%
  pinmnumber=13,pinnnumber=14,pinonumber=15,pinpnumber=16,%
  pinqnumber=17,pinrnumber=18,pinsnumber=19,pintnumber=20]%
  (0,0){Name}
\end{pspicture}

```

20-Pin DIP IC all inverted

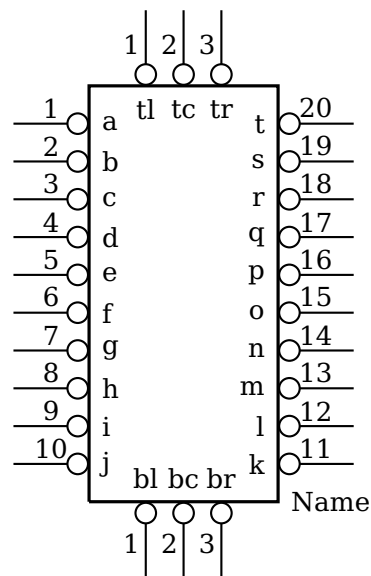

```

\begin{pspicture}(-1,-2)(5,7)
\logicic[nicpins=20,%
  pintl=true,pintllabel=tl,pintlnumber=1,%
  pintc=true,pintclabel=tc,pintcnumber=2,%
  pintr=true,pintrlabel=tr,pintrnumber=3,%
  invertpintl=true,invertpintc=true,invertpintr=true,%
  pinbl=true,pinbllabel=bl,pinblnumber=1,%
  pinbc=true,pinbclabel=bc,pinbcnumber=2,%
  pinbr=true,pinbrlabel=br,pinbrnumber=3,%
  invertpinbl=true,invertpinbc=true,invertpinbr=true,%
  pinalabel=a,pinblabel=b,pinclabel=c,pindlabel=d,%
  pinelabel=e,pinflabel=f,pinglabel=g,pinhlabeled=h,%
  pinilabel=i,pinjlabel=j,pinklabel=k,pinllabel=l,%
  pinmlabel=m,pinnlabel=n,pinolabel=o,pinplabel=p,%
  pinqlabel=q,pinrlabel=r,pinslabel=s,pintlabeled=t,%
  pinanumber=1,pinbnumber=2,pincnumber=3,pindnumber=4,%
  pinenumber=5,pinfnumber=6,pingnumber=7,pinhnumber=8,
  pininumber=9,pinjnumber=10,pinknumber=11,pinlnumber=12,%
  pinmnumber=13,pinnnumber=14,pinonumber=15,pinpnumber=16,%
  pinqnumber=17,pinrnumber=18,pinsnumber=19,pintnumber=20,%
  invertpina=true,invertpinb=true,invertpinc=true,invertpind=true,%
  invertpine=true,invertpinf=true,invertping=true,invertpinh=true,%
  invertpini=true,invertpinj=true,invertpink=true,invertpinl=true,%
  invertpinm=true,invertpinn=true,invertpino=true,invertpinp=true,%
  invertpinq=true,invertpinr=true,invertpins=true,invertpint=true]%
(0,0){Name}
\end{pspicture}

```

32-Pin DIP IC

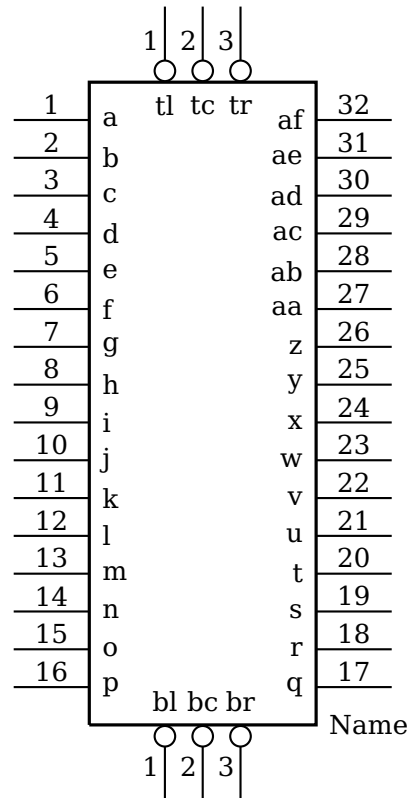

```

\begin{pspicture}(-1,-2)(6,9.5)
\logicic[nicpins=32, pintl=true,pintllabel=tl,pintlnumber=1,
pintc=true,pintclabel=tc,pintcnumber=2,pintr=true,pintrlabel=tr,pintrnumber=3,%
invertpintl=true,invertpintc=true,invertpintr=true,
pinbl=true,pinbllabel=bl,pinblnumber=1,pinbc=true,pinbclabel=bc,pinbcnumber=2,%
pinbr=true,pinbrlabel=br,pinbrnumber=3,%
invertpinbl=true,invertpinbc=true,invertpinbr=true,%
pinalabel=a,pinblabel=b,pinclabel=c,pindlabel=d,%
pinelabel=e,pinflabel=f,pinglabel=g,pinhlable=h,%
pinilabel=i,pinjlabel=j,pinklabe=k,pinllabel=l,%
pinmlabel=m,pinnlabel=n,pinolabel=o,pinplabel=p,%
pinqlabel=q,pinrlabel=r,pinslabel=s,pintlabe=t,%
pinulabel=u,pinvlabel=v,pinwlabel=w,pinxlabel=x,%
pinylabel=y,pinzlabel=z,pinaalabel=aa,pinablabe=ab,%
pinaclabel=ac,pinadlabel=ad,pinaelabel=ae,pinaflabel=af,%
pinanumber=1,pinbnumber=2,pincnumber=3,pindnumber=4,%
pinenumber=5,pinfnumber=6,pingnumber=7,pinhnumber=8,
pininumber=9,pinjnumber=10,pinknumber=11,pinlnumber=12,%
pinmnumber=13,pinnnumber=14,pinonumber=15,pinpnumber=16,%
pinqnumber=17,pinrnumber=18,pinsnumber=19,pintnumber=20,%
pinunumber=21,pinvnumber=22,pinwnumber=23,pinxnumber=24,%
pinynumber=25,pinznumber=26,pinaanumber=27,pinabnumber=28,%
pinacnumber=29,pinadnumber=30,pinaenumber=31,pinafnumber=32](0,0){Name}
\end{pspicture}

```

32-Pin DIP IC all inverted

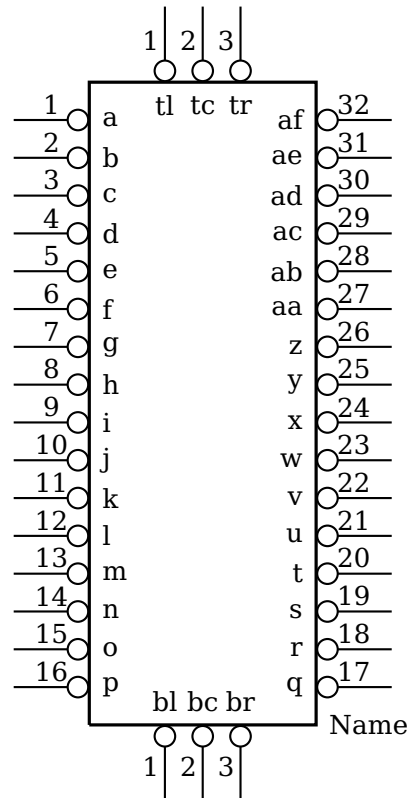

```

\begin{pspicture}(-1,-2)(6,9.5)
\logicic[nicpins=32,%
pintl=true,pintllabel=tl,pintlnumber=1,%
pintc=true,pintclabel=tc,pintcnumber=2,%
pintr=true,pintrlabel=tr,pintrnumber=3,%
invertpintl=true,invertpintc=true,invertpintr=true,%
pinbl=true,pinbllabel=bl,pinblnumber=1,%
pinbc=true,pinbclabel=bc,pinbcnumber=2,%
pinbr=true,pinbrlabel=br,pinbrnumber=3,%
invertpinbl=true,invertpinbc=true,invertpinbr=true,%
pinalabel=a,pinblabel=b,pinclabel=c,pindlabel=d,%
pinelabel=e,pinflabel=f,pinglabel=g,pinhlabel=h,%
pinilabel=i,pinjlabel=j,pinklabel=k,pinllabel=l,%
pinmlabel=m,pinnlabel=n,pinolabel=o,pinplabel=p,%
pinqlabel=q,pinrlabel=r,pinslabel=s,pintllabel=t,%
pinulabel=u,pinvlabel=v,pinwlabel=w,pinxlabel=x,%
pinylabel=y,pinzlabel=z,pinaalabel=aa,pinablabel=ab,%
pinaclabel=ac,pinadlabel=ad,pinaelabel=ae,pinaflabel=af,%
pinanumber=1,pinbnumber=2,pincnumber=3,pindnumber=4,%
pinenumber=5,pinfnumber=6,pingnumber=7,pinhnumber=8,%
pininumber=9,pinjnumber=10,pinknumber=11,pinlnumber=12,%
pinmnumber=13,pinnnumber=14,pinonumber=15,pinpnumber=16,%
pinqnumber=17,pinrnumber=18,pinsnumber=19,pintnumber=20,%
pinunumber=21,pinvnumber=22,pinwnumber=23,pinxnumber=24,%
pinynumber=25,pinznumber=26,pinaanumber=27,pinabnumber=28,%

```

```
pinacnumber=29,pinadnumber=30,pinaenumber=31,pinafnumber=32,%  
invertpina=true,invertpinb=true,invertpinc=true,invertpind=true,%  
invertpine=true,invertpinf=true,invertping=true,invertpinh=true,%  
invertpini=true,invertpinj=true,invertpink=true,invertpinl=true,%  
invertpinm=true,invertpinn=true,invertpino=true,invertpinp=true,%  
invertpinq=true,invertpinr=true,invertpins=true,invertpint=true,%  
invertpinu=true,invertpinv=true,invertpinw=true,invertpinx=true,%  
invertpiny=true,invertpinz=true,invertpinaa=true,invertpinab=true,%  
invertpinac=true,invertpinad=true,invertpinae=true,invertpinaf=true]%  
(0,0){Name}  
\end{pspicture}
```

7 Relay Ladder Logic

XIC

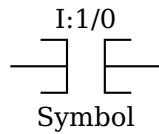

```
\begin{pspicture}(-1,-1)(1,1)
\xic[pladdress=I:1/0,
plcsymbol=Symbol](0,0)
\end{pspicture}
```

XIO

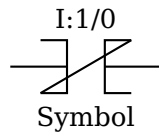

```
\begin{pspicture}(-1,-1)(1,1)
\xio[pladdress=I:1/0,
plcsymbol=Symbol](0,0)
\end{pspicture}
```

OTE

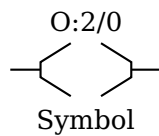

```
\begin{pspicture}(-1,-1)(1,1)
\ote[pladdress=O:2/0,
plcsymbol=Symbol](0,0)
\end{pspicture}
```

OTL

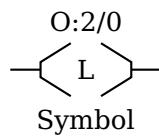

```
\begin{pspicture}(-1,-1)(1,1)
\ote[latch=true,
pladdress=O:2/0,
plcsymbol=Symbol](0,0)
\end{pspicture}
```

OTE

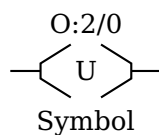

```
\begin{pspicture}(-1,-1)(1,1)
\ote[unlatch=true,
pladdress=O:2/0,
plcsymbol=Symbol](0,0)
\end{pspicture}
```

OSR

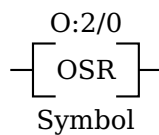

```
\begin{pspicture}(-1,-1)(1,1)
\osr[pladdress=O:2/0,
plcsymbol=Symbol](0,0)
\end{pspicture}
```

RES

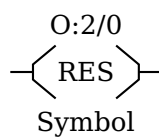

```
\begin{pspicture}(-1,-1)(1,1)
\res[pladdress=O:2/0,
plcsymbol=Symbol](0,0)
\end{pspicture}
```

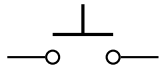
Switch PB NO

```
\begin{pspicture}(-1,-1)(1,1)
  \swpb(0,0)
\end{pspicture}
```

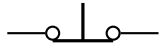
Switch PB NC

```
\begin{pspicture}(-1,-1)(1,1)
  \swpb[contactclosed=true](0,0)
\end{pspicture}
```

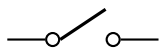
Switch TOGGLE NO

```
\begin{pspicture}(-1,-1)(1,1)
  \swtog(0,0)
\end{pspicture}
```

Switch PB NC

```
\begin{pspicture}(-1,-1)(1,1)
  \swtog[contactclosed=true](0,0)
\end{pspicture}
```

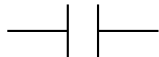
Contact NO

```
\begin{pspicture}(-1,-1)(1,1)
  \contact(0,0)
\end{pspicture}
```

Contact NC

```
\begin{pspicture}(-1,-1)(1,1)
  \contact[contactclosed=true](0,0)
\end{pspicture}
```

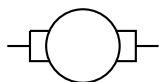
Motor Armature

```
\begin{pspicture}(-1,-1)(1,1)
  \armature(0,0)
\end{pspicture}
```

7.1 Examples

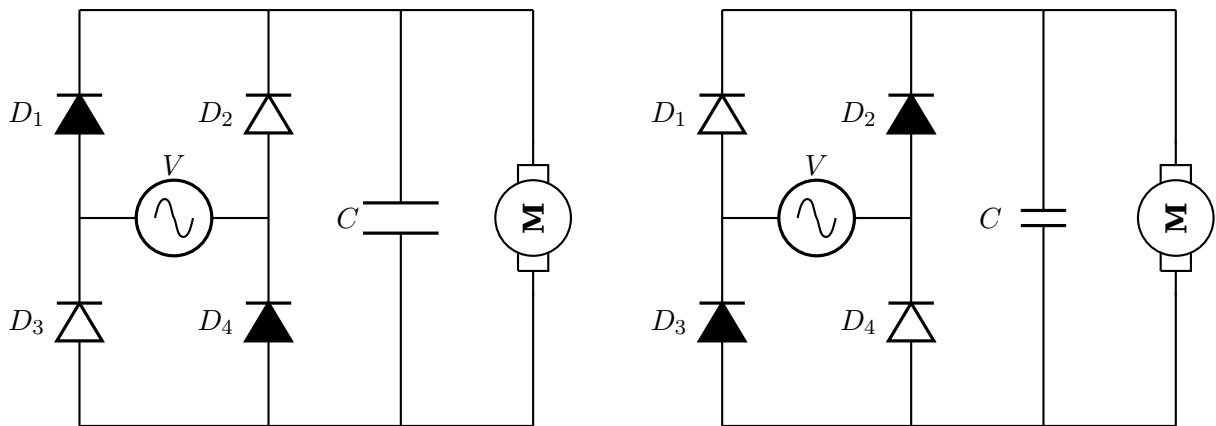

```

\begin{pspicture}(0,0)(15,6)
  \pnode(0.5,0){A} \pnode(0.5,2.75){B} \pnode(0.5,5.5){C}
  \pnode(3,0){D} \pnode(3,2.75){E} \pnode(3,5.5){F}
  \pnode(4.75,0){G} \pnode(4.75,5.50){H}
  \pnode(6.5,0){I} \pnode(6.5,5.5){J}
  \vac(B)(E){$V$}
  \newdiode(B)(C){$D_1$}
  \newdiode[ison=false](E)(F){$D_2$}
  \newdiode[ison=false](A)(B){$D_3$}
  \newdiode(D)(E){$D_4$}
  \capacitor(G)(H){$C$}
  \newarmature[labelInside=1](I)(J){}
  \wire(C)(F) \wire(A)(D) \wire(D)(G) \wire(I)(G) \wire(F)(H) \wire(H)(J)

  \pnode(9,0){K} \pnode(9,2.75){L} \pnode(9,5.5){M}
  \pnode(11.5,0){N} \pnode(11.5,2.75){O}
  \pnode(11.5,5.5){P}
  \pnode(13.25,0){Q} \pnode(13.25,5.5){R}
  \pnode(15,0){S} \pnode(15,5.5){T}
  \vac(L)(O){$V$}
  \newdiode[ison=false](L)(M){$D_1$}
  \newdiode(O)(P){$D_2$}
  \newdiode(K)(L){$D_3$}
  \newdiode[ison=false](N)(O){$D_4$}
  \newcapacitor(Q)(R){$C$}
  \newarmature[labelInside=1](S)(T){}
  \wire(M)(P) \wire(K)(N) \wire(N)(Q) \wire(S)(Q) \wire(P)(R) \wire(R)(T)
\end{pspicture}

```

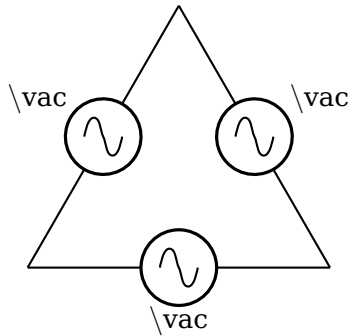

```
\begin{pspicture}(-1,-1)(4,4)
  \vac[labeloffset=-0.7](0,0)(4,0){$\backslash$vac}
  \vac[labeloffset=1](0,0)(2,3.464){$\backslash$vac}
  \vac[labeloffset=1](2,3.464)(4,0){$\backslash$vac}
\end{pspicture}
```

8 Adding new components

Adding new components is not simple unless you need only a simple dipole. For dipoles a macro is provided that generates all helping macros for a new component so that you need to write only the actual drawing code.

If you want to add a new dipole component, you only need the following code:

```
\newCircDipole{ComponentName}%
\def\pst@draw@ComponentName{%
  % The PSTricks code for your component
  % The center of the component is at (0,0)
  \pnode(component_left_end,0){dipole@1}
  \pnode(component_right_end,0){dipole@2}}
```

This code can be placed in the core code or somewhere in the respective document in which case it must be surrounded by `\makeatletter... \makeatother`.

If your new dipole should also work with `\multidipole` then you have to make some changes in the `\multidipole` core code. In the definition of `\pst@multidipole`, look for the last `\ifx` test

```
% ...
% Extract from \pst@multidipole
\else\ifx\OpenDipol #4\let\pscirc@next\pst@multidipole@OpenDipol% 27
\else\ifx\OpenTripol #4\let\pscirc@next\pst@multidipole@OpenTripol% 28
\else % Put your modification here
\else\let\pscirc@next\ignorespaces
\fi\fi\fi
% Extract form \pst@multidipole
% ...
```

and add (marked with %%)

```
% ...
% Extract from \pst@multidipole
\else\ifx\OpenDipol #4\let\pscirc@next\pst@multidipole@OpenDipol% 27
\else\ifx\OpenTripol #4\let\pscirc@next\pst@multidipole@OpenTripol% 28
\else\ifx\ComponentName#4\let\next\pst@multidipole@ComponentName%%
\else\let\pscirc@next\ignorespaces
\fi\fi\fi
% Extract form \pst@multidipole
% ...
```

Do the same in `\pst@multidipole@`

```
% ...
% Extract from \pst@multidipole@
\else\ifx\OpenDipol#1\let\pscirc@next\pst@multidipole@OpenDipol% 27
\else\ifx\OpenTripol#1\let\pscirc@next\pst@multidipole@OpenTripol% 28
\else\ifx\ComponentName#1\let\next\pst@multidipole@ComponentName%%
\else\let\pscirc@next\ignorespaces\pst@multidipole@output
\fi\fi\fi
% Extract form \pst@multidipole@
% ...
```

and that's it! All you have to do then is send your modified `pst-circ.tex` to me and it will become part of the official release of `pst-circ`.

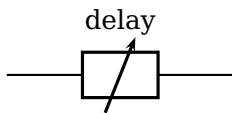

```
\begin{pspicture}(3,2)
\newCircDipole{delayline}
\makeatletter
\def\pst@draw@delayline{%
\psset{linewidth=1.5\pslinewidth}%
\psframe(-0.5,-0.3)(0.5,0.3)
\psline[arrows=->](-0.2,-0.5)(0.2,0.5)
\pnode(-0.5,0){dipole@1}
\pnode(0.5,0){dipole@2}}%
\makeatother
\pnode(0,1){A}\pnode(3,1){B}
\delayline(A)(B){delay}
\end{pspicture}
```

9 List of all optional arguments for pst-circ

Note: the default for booleans is always false.

Key	Type	Default
intensity	boolean	true
mathlabel	boolean	true
labelstyle	ordinary	
intensitylabel	ordinary	
intensitylabelcolor	ordinary	black
intensitylabeloffset	ordinary	0.5
intensitycolor	ordinary	black
intensitywidth	ordinary	\pslinewidth
tension	boolean	true
tensionstyle	ordinary	line
tensionlabel	ordinary	
tensionlabelcolor	ordinary	black
tensionoffset	ordinary	1
tensionlabeloffset	ordinary	1.2
tensioncolor	ordinary	black
tensionwidth	ordinary	\pslinewidth
labeloffset	ordinary	0.7
labelangle	ordinary	0
labelInside	ordinary	0
dipoleconvention	ordinary	receptor
directconvention	boolean	true
dipolestyle	ordinary	normal
parallel	ordinary	true
parallelarm	ordinary	1.5
parallelep	ordinary	0
parallelnode	ordinary	true
intersect	boolean	true
intersectA	ordinary	[none]
intersectB	ordinary	[none]
OAperfect	boolean	true
OApower	boolean	true
OAinvert	boolean	true
OAiplus	boolean	true
OAiminus	boolean	true
OAiout	boolean	true
OAipluslabel	ordinary	
OAiminuslabel	ordinary	
OAioutlabel	ordinary	
transistorcircle	boolean	true
transistorinvert	boolean	true

Continued on next page

Continued from previous page

Key	Type	Default
transistoribase	boolean	true
transistoricollector	boolean	true
transistoriemitter	boolean	true
transistoribaselabel	ordinary	
transistoricollectorlabel	ordinary	
transistoriemitterlabel	ordinary	
FETchanneltype	ordinary	[none]
FETmemory	boolean	true
transistortype	ordinary	NPN
basesep	ordinary	0
TRot	ordinary	0
circedge	ordinary	\pcangle
primarylabel	ordinary	
secondarylabel	ordinary	
transformerprimary	ordinary	true
transformersecondary	ordinary	true
transformerprimarylabel	ordinary	
transformersecondarylabel	ordinary	
tripolestype	ordinary	normal
variable	boolean	true
logicChangeLR	boolean	true
logicShowDot	boolean	true
logicShowNode	boolean	true
logicWidth	ordinary	1.5
logicHeight	ordinary	2.5
logicType	ordinary	and
logicNInput	ordinary	2
logicJInput	ordinary	2
logicKInput	ordinary	2
logicWireLength	ordinary	0.5
logicLabelstyle	ordinary	\small
logicSymbolstyle	ordinary	\large
logicSymbolpos	ordinary	0.5
logicNodestyle	ordinary	\footnotesize
ninputs	choice	2
ninputs	choice	[none]
segmentdisplay	choice	10
segmentdisplay	choice	[none]
nicpins	choice	8
nicpins	choice	[none]
bubblesize	choice	0.15
bubblesize	choice	[none]
segmentcolor	ordinary	black

Continued on next page

Continued from previous page

Key	Type	Default
inputalabel	ordinary	
inputblabel	ordinary	
inputclabel	ordinary	
inputenlabel	ordinary	
inputcllabel	ordinary	
outputalabel	ordinary	
outputblabel	ordinary	
outputclabel	ordinary	
pinalabel	ordinary	
pinanumber	ordinary	
pinblabel	ordinary	
pinbnumber	ordinary	
pinclabel	ordinary	
pincnumber	ordinary	
pindlabel	ordinary	
pindnumber	ordinary	
pinelabel	ordinary	
pinenumber	ordinary	
pinflabel	ordinary	
pinfnumber	ordinary	
pinglabel	ordinary	
pingnumber	ordinary	
pinhlabel	ordinary	
pinhnumber	ordinary	
pinilabel	ordinary	
pininumber	ordinary	
pinjlabel	ordinary	
pinjnumber	ordinary	
pinklabel	ordinary	
pinknumber	ordinary	
pinllabel	ordinary	
pinlnumber	ordinary	
pinmlabel	ordinary	
pinmnumber	ordinary	
pinmlabel	ordinary	
pinnumber	ordinary	
pinolabel	ordinary	
pinonumber	ordinary	
pinplabel	ordinary	
pinpnumber	ordinary	
pinqlabel	ordinary	
pinqnumber	ordinary	
pinrlabel	ordinary	

Continued on next page

Continued from previous page

Key	Type	Default
pinrnumber	ordinary	
pinslabel	ordinary	
pinsnumber	ordinary	
pintlabe	ordinary	
pintnumber	ordinary	
pinulabe	ordinary	
pinunumber	ordinary	
pinvlabe	ordinary	
pinvnumber	ordinary	
pinwlabe	ordinary	
pinwnumber	ordinary	
pinxlabe	ordinary	
pinxnumber	ordinary	
pinylabe	ordinary	
pinynumber	ordinary	
pinzlabe	ordinary	
pinznumber	ordinary	
pinaalabe	ordinary	
pinaanumber	ordinary	
pinablabe	ordinary	
pinabnumber	ordinary	
pinacalabe	ordinary	
pinacnumber	ordinary	
pinadlabe	ordinary	
pinadnumber	ordinary	
pinaelabe	ordinary	
pinaenumber	ordinary	
pinafalabe	ordinary	
pinafnumber	ordinary	
pinralabe	ordinary	
pinranumber	ordinary	
pinrblabe	ordinary	
pinrbnumber	ordinary	
pinrcalabe	ordinary	
pinrcnumber	ordinary	
pinrdlabe	ordinary	
pinrdnumber	ordinary	
pinrelabe	ordinary	
pinrenumber	ordinary	
pinrfalabe	ordinary	
pinrfnumber	ordinary	
pinrgalabe	ordinary	
pinrgnumber	ordinary	

Continued on next page

Continued from previous page

Key	Type	Default
pinrhlabel	ordinary	
pinrhnumber	ordinary	
pinrilabel	ordinary	
pinrinumber	ordinary	
pinrjlabel	ordinary	
pinrjnumber	ordinary	
pinrklabel	ordinary	
pinrknumber	ordinary	
pinrllabel	ordinary	
pinrlnumber	ordinary	
pinrmlabel	ordinary	
pinrmnumber	ordinary	
pinrnlabel	ordinary	
pinrnnumber	ordinary	
pinrolabel	ordinary	
pinronumber	ordinary	
pinrplabel	ordinary	
pinrpnumber	ordinary	
pinlalabel	ordinary	
pinlanumber	ordinary	
pinlblabel	ordinary	
pinlbnumber	ordinary	
pinlclabel	ordinary	
pinlcnumber	ordinary	
pinldlabel	ordinary	
pinldnumber	ordinary	
pinlelabel	ordinary	
pinlenumber	ordinary	
pinlflabel	ordinary	
pinlfnnumber	ordinary	
pinlglabel	ordinary	
pinlgnumber	ordinary	
pinlhlabel	ordinary	
pinlhnumber	ordinary	
pinlilabel	ordinary	
pinlinumber	ordinary	
pinljlabel	ordinary	
pinljnumber	ordinary	
pinlklabel	ordinary	
pinlknumber	ordinary	
pinlllabel	ordinary	
pinllnumber	ordinary	
pinmllabel	ordinary	

Continued on next page

Continued from previous page

Key	Type	Default
pinlmnumber	ordinary	
pinlnlabel	ordinary	
pinlnnumber	ordinary	
pinlolabel	ordinary	
pinlonumber	ordinary	
pinlplabel	ordinary	
pinlpnumber	ordinary	
pintllabel	ordinary	
pintlnumber	ordinary	
pintclabel	ordinary	
pintcnumber	ordinary	
pintrlabel	ordinary	
pintrnumber	ordinary	
pinbllabel	ordinary	
pinblnumber	ordinary	
pinbclabel	ordinary	
pinbcnumber	ordinary	
pinbrlabel	ordinary	
pinbrnumber	ordinary	
pintalabel	ordinary	
pintanumber	ordinary	
pintblabel	ordinary	
pintbnumber	ordinary	
pintclabel	ordinary	
pintcnumber	ordinary	
pintdlabel	ordinary	
pintdnumber	ordinary	
pintelabel	ordinary	
pintenumber	ordinary	
pinbalabel	ordinary	
pinbanumber	ordinary	
pinbblabel	ordinary	
pinbbnumber	ordinary	
pinbclabel	ordinary	
pinbcnumber	ordinary	
pinbdlabel	ordinary	
pinbdnumber	ordinary	
pinbelabel	ordinary	
pinbenumber	ordinary	
plcaddress	ordinary	
plcsymbol	ordinary	
iec	ordinary	false
iecinvert	ordinary	false

Continued on next page

Continued from previous page

Key	Type	Default
input	ordinary	true
invertinput	ordinary	false
inputa	ordinary	true
invertinputa	ordinary	false
inputb	ordinary	true
invertinputb	ordinary	false
inputc	ordinary	true
invertinputc	ordinary	false
inputd	ordinary	true
invertinputd	ordinary	false
enable	ordinary	false
invertenable	ordinary	false
clock	ordinary	false
invertclock	ordinary	false
set	ordinary	false
invertset	ordinary	false
reset	ordinary	false
invertreset	ordinary	false
output	ordinary	true
invertoutput	ordinary	false
outputa	ordinary	true
invertoutputa	ordinary	false
outputb	ordinary	true
invertoutputb	ordinary	true
segmentlabels	ordinary	true
pina	ordinary	true
invertpina	ordinary	false
pinb	ordinary	true
invertpinb	ordinary	false
pinc	ordinary	true
invertpinc	ordinary	false
pin d	ordinary	true
invertpin d	ordinary	false
pine	ordinary	true
invertpine	ordinary	false
pinf	ordinary	true
invertpinf	ordinary	false
ping	ordinary	true
invertping	ordinary	false
pinh	ordinary	true
invertpinh	ordinary	false
pin i	ordinary	true
invertpin i	ordinary	false

Continued on next page

Continued from previous page

Key	Type	Default
pinj	ordinary	true
invertpinj	ordinary	false
pink	ordinary	true
invertpink	ordinary	false
pinl	ordinary	true
invertpinl	ordinary	false
pinm	ordinary	true
invertpinm	ordinary	false
pinn	ordinary	true
invertpinn	ordinary	false
pino	ordinary	true
invertpino	ordinary	false
pinp	ordinary	true
invertpinp	ordinary	false
pinq	ordinary	true
invertpinq	ordinary	false
pinr	ordinary	true
invertpinr	ordinary	false
pins	ordinary	true
invertpins	ordinary	false
pint	ordinary	true
invertpint	ordinary	false
pinu	ordinary	true
invertpinu	ordinary	false
pinv	ordinary	true
invertpinv	ordinary	false
pinw	ordinary	true
invertpinw	ordinary	false
pinx	ordinary	true
invertpinx	ordinary	false
piny	ordinary	true
invertpiny	ordinary	false
pinz	ordinary	true
invertpinz	ordinary	false
pinaa	ordinary	true
invertpinaa	ordinary	false
pinab	ordinary	true
invertpinab	ordinary	false
pinac	ordinary	true
invertpinac	ordinary	false
pinad	ordinary	true
invertpinad	ordinary	false
pinae	ordinary	true

Continued on next page

Continued from previous page

Key	Type	Default
invertpin _a e	ordinary	false
pin _a f	ordinary	true
invertpin _a f	ordinary	false
pin _a l	ordinary	true
invertpin _a l	ordinary	false
pin _a l _b	ordinary	true
invertpin _a l _b	ordinary	false
pin _a l _c	ordinary	true
invertpin _a l _c	ordinary	false
pin _a l _d	ordinary	true
invertpin _a l _d	ordinary	false
pin _a l _e	ordinary	true
invertpin _a l _e	ordinary	false
pin _a l _f	ordinary	true
invertpin _a l _f	ordinary	false
pin _a l _g	ordinary	true
invertpin _a l _g	ordinary	false
pin _a l _h	ordinary	true
invertpin _a l _h	ordinary	false
pin _a l _i	ordinary	true
invertpin _a l _i	ordinary	false
pin _a l _j	ordinary	true
invertpin _a l _j	ordinary	false
pin _a l _k	ordinary	true
invertpin _a l _k	ordinary	false
pin _a l _l	ordinary	true
invertpin _a l _l	ordinary	false
pin _a l _m	ordinary	true
invertpin _a l _m	ordinary	false
pin _a l _n	ordinary	true
invertpin _a l _n	ordinary	false
pin _a l _o	ordinary	true
invertpin _a l _o	ordinary	false
pin _a l _p	ordinary	true
invertpin _a l _p	ordinary	false
pin _a r _a	ordinary	true
invertpin _a r _a	ordinary	false
pin _a r _b	ordinary	true
invertpin _a r _b	ordinary	false
pin _a r _c	ordinary	true
invertpin _a r _c	ordinary	false
pin _a r _d	ordinary	true
invertpin _a r _d	ordinary	false

Continued on next page

Continued from previous page

Key	Type	Default
pinre	ordinary	true
invertpinre	ordinary	false
pinrf	ordinary	true
invertpinrf	ordinary	false
pinrg	ordinary	true
invertpinrg	ordinary	false
pinrh	ordinary	true
invertpinrh	ordinary	false
pinri	ordinary	true
invertpinri	ordinary	false
pinrj	ordinary	true
invertpinrj	ordinary	false
pinrk	ordinary	true
invertpinrk	ordinary	false
pinrl	ordinary	true
invertpinrl	ordinary	false
pinrm	ordinary	true
invertpinrm	ordinary	false
pinrn	ordinary	true
invertpinrn	ordinary	false
pinro	ordinary	true
invertpinro	ordinary	false
pinrp	ordinary	true
invertpinrp	ordinary	false
pintl	ordinary	false
invertpintl	ordinary	false
pintc	ordinary	false
invertpintc	ordinary	false
pintr	ordinary	false
invertpintr	ordinary	false
pinbl	ordinary	false
invertpinbl	ordinary	false
pinbc	ordinary	false
invertpinbc	ordinary	false
pinbr	ordinary	false
invertpinbr	ordinary	false
pinta	ordinary	false
invertpinta	ordinary	false
pintb	ordinary	false
invertpintb	ordinary	false
pintc	ordinary	false
invertpintc	ordinary	false
pintd	ordinary	false

Continued on next page

Continued from previous page

Key	Type	Default
invertpintd	ordinary	false
pinte	ordinary	false
invertpinte	ordinary	false
pinba	ordinary	false
invertpinba	ordinary	false
pinbb	ordinary	false
invertpinbb	ordinary	false
pinbc	ordinary	false
invertpinbc	ordinary	false
pinbd	ordinary	false
invertpinbd	ordinary	false
pinbe	ordinary	false
invertpinbe	ordinary	false
dpleft	ordinary	false
dpright	ordinary	true
latch	ordinary	false
unlatch	ordinary	false
contactclosed	ordinary	false
polarized	ordinary	false
ison	ordinary	true
inputarrow	boolean	true
programmable	boolean	true
connectingdot	boolean	true
groundstyle	ordinary	ads
antennastyle	ordinary	two
output	ordinary	top
L0style	ordinary	
dipoleinput	ordinary	left
value	ordinary	0
tripoleinput	ordinary	left
tripoleconfig	ordinary	left
couplerstyle	ordinary	hxbrid
quadripoleinput	ordinary	left

References

- [1] Michel Goosens, Frank Mittelbach, Serbastian Rahtz, Denis Roegel, and Herbert Voß. *The L^AT_EX Graphics Companion*. Addison-Wesley Publishing Company, Reading, Mass., 2nd edition, 2007.
- [2] Laura E. Jackson and Herbert Voß. Die Plot-Funktionen von pst-plot. *Die T_EXnische Komödie*, 2/02:27–34, June 2002.

-
- [3] Nikolai G. Kollock. *PostScript richtig eingesetzt: vom Konzept zum praktischen Einsatz*. IWT, Vaterstetten, 1989.
- [4] Herbert Voß. Die mathematischen Funktionen von Postscript. *Die T_EXnische Komödie*, 1/02:40–47, March 2002.
- [5] Herbert Voß. *PSTricks – Grafik für T_EX und L^AT_EX*. DANTE/Lehmanns, Heidelberg/Berlin, 6. edition, 2010.
- [6] Herbert Voß. *Typsetting mathematics with L^AT_EX*. UIT, Cambridge – UK, 2010.
- [7] Herbert Voß. *PSTricks – Graphics and PostScript for L^AT_EX*. UIT, Cambridge – UK, 1st edition, 2011.
- [8] Michael Wiedmann and Peter Karp. *References for T_EX and Friends*. <http://www.miwie.org/tex-refs/>, 2003.

Index

:U, 13, 19, 20

ads, 35

and, 45, 46

antennastyle, 35

\Arrestor, 6

arrows, 14

arrows, 8

\arrowswitch, 5

bandpass, 36

basesep, 8, 15

\battery, 4, 19

bottom, 36, 39

bubblesize, 55, 56

\caoacitor, 11

\capacitor, 4, 17, 18

chemical, 17

\circledipole, 6, 34

circulator, 40

clock, 56

\coil, 4, 18, 19

Collector, 8

\contact, 56

contactclosed, 56

couplerstyle, 41

crystal, 17, 36

curved, 18

D, 51

\diode, 5, 11, 18

dipoleconvention, 14

dipoleinput, 36–39

dipolestyle, 17–19, 36, 37

directconvention, 14

directional, 41

divider, 37

elektor, 17–19

elektorchemical, 17

elektorcurved, 18

Emitter, 8

enable, 56

exnor, 50

exor, 49, 50

FET, 22

FETchannel, 22

FETmemory, 22

File

 pst-circ.tex, 80

\filter, 36, 37

french, 20

generator, 14

\ground, 12

groundstyle, 35

GT0, 18

highpass, 36, 37

hybrid, 41

\ICC, 17

\Icc, 5

iec, 55

iecinvert, 55

\ifx, 79

input, 55

inputa, 55

inputalabel, 56

inputarrow, 36–41

inputb, 56

inputblabel, 56

intensity, 14

intensitycolor, 14

intensitylabel, 14

intensitylabelcolor, 14

intensitylabeloffset, 14

intensitywidth, 14

invertclock, 56

invertenable, 56

invertinput, 55

invertinputa, 55

invertinputb, 56

invertoutput, 55

invertreset, 56

invertset, 56

- isolator, 40
- JK, 51
- Keyvalue
 - ads, 35
 - and, 45
 - bandpass, 36
 - bottom, 36, 39
 - circulator, 40
 - crystal, 36
 - directional, 41
 - divider, 37
 - generator, 14
 - highpass, 36
 - hybrid, 41
 - isolator, 40
 - left, 36–41
 - lowpass, 36
 - multiplier, 37
 - N, 37
 - old, 35
 - receptor, 14
 - right, 36–41
 - three, 35
 - top, 36, 39
 - triangle, 35
 - two, 35
- Keyword
 - antennastyle, 35
 - arrows, 8
 - basesep, 8, 15
 - bubblesize, 55, 56
 - clock, 56
 - contactclosed, 56
 - couplerstyle, 41
 - dipoleconvention, 14
 - dipoleinput, 36–39
 - dipolestyle, 17–19, 36, 37
 - directconvention, 14
 - enable, 56
 - FETchannel, 22
 - FETmemory, 22
 - groundstyle, 35
 - iec, 55
 - iecinvert, 55
 - input, 55
 - inputa, 55
 - inputalabel, 56
 - inputarrow, 36–41
 - inputb, 56
 - inputlabel, 56
 - intensity, 14
 - intensitycolor, 14
 - intensitylabel, 14
 - intensitylabelcolor, 14
 - intensitylabeloffset, 14
 - intensitywidth, 14
 - invertclock, 56
 - invertenable, 56
 - invertinput, 55
 - invertinputa, 55
 - invertinputb, 56
 - invertoutput, 55
 - invertreset, 56
 - invertset, 56
 - labelangle, 13, 19, 20
 - labelInside, 13
 - labeloffset, 6, 13, 20
 - latch, 56
 - logicChangeLR, 45–51
 - logicHeight, 45–50
 - logicJInput, 45, 51
 - logicKInput, 45, 51
 - logicLabelstyle, 45, 52
 - logicNInput, 45–50
 - logicNodestyle, 45
 - logicShowDot, 45, 51
 - logicShowNode, 45–51
 - logicSymbolpos, 45
 - logicSymbolstyle, 45, 52
 - logicType, 45–51
 - logicWidth, 45–50
 - logicWireLength, 45, 51, 52
 - L0style, 36
 - nicpins, 56
 - ninputs, 55
 - nodesep, 8
 - OAminuslabel, 15
 - OAINvert, 21
 - OAIoutlabel, 15

- OApluslabel, 15
 - OApertect, 21
 - OApower, 7
 - output, 36
 - parallel, 15, 16
 - plcaddress, 56
 - plcsymbol, 56
 - primarylabel, 13
 - programmable, 37
 - quadripoleinput, 41
 - reset, 56
 - secondarylabel, 13
 - set, 56
 - tension, 14
 - tensioncolor, 14
 - tensionlabel, 14
 - tensionlabelcolor, 14
 - tensionlabeloffset, 14
 - tensionoffset, 14
 - tensionstyle, 14
 - tensionwidth, 14
 - transformeriprimarylabel, 15
 - transformerisecondarylabel, 15
 - transistoribaselabel, 15
 - transistoricollectorlabel, 15
 - transistoriemitter, 8
 - transistoriemitterlabel, 15
 - transistorinvert, 8
 - transistoritype, 7, 8, 22
 - tripoleconfig, 40
 - tripoleinput, 40
 - tripolestytle, 19, 20, 39, 40
 - TRot, 7
 - unit, 52
 - unlatch, 56
 - value, 37
 - variable, 18, 19
 - zigzag, 19
- labelangle, 13, 19, 20
- labelInside, 13
- labeloffset, 6, 13, 20
- \lamp, 5
- latch, 56
- \LED, 6
- left, 19, 36–41
- \logic, 45
- \logicand, 55
- logicChangeLR, 45–51
- \logicff, 55
- logicHeight, 45–50
- \logicic, 56
- logicJInput, 45, 51
- logicKInput, 45, 51
- logicLabelstyle, 45, 52
- logicNInput, 45–50
- logicNodestyle, 45
- \logicnot, 55
- \logicor, 55
- logicShowDot, 45, 51
- logicShowNode, 45–51
- logicSymbolpos, 45
- logicSymbolstyle, 45, 52
- logicType, 45–51
- logicWidth, 45–50
- logicWireLength, 45, 51, 52
- \logicxor, 55
- L0style, 36
- lowpass, 36
- Macro
- \Arrestor, 6
 - \arrowswitch, 5
 - \battery, 4, 19
 - \caoacitor, 11
 - \capacitor, 4, 17, 18
 - \circledipole, 6, 34
 - \coil, 4, 18, 19
 - \contact, 56
 - \diode, 5, 11, 18
 - \filter, 36, 37
 - \ground, 12
 - \ICC, 17
 - \Icc, 5
 - \ifx, 79
 - \lamp, 5
 - \LED, 6
 - \logic, 45
 - \logicand, 55
 - \logicff, 55
 - \logicic, 56
 - \logicnot, 55

- `\logicor`, 55
- `\logicxor`, 55
- `\multidipole`, 11, 12, 16, 17, 35, 79
- `\ncangle`, 6
- `\NewDiode`, 24
- `\NewLED`, 24
- `\NewSwitch`, 24
- `\newtransformer`, 11
- `\newtransformerquad`, 11
- `\NewZener`, 24
- `\OA`, 6, 20, 21
- `\OpenDipol`, 13
- `\OpenTripol`, 13
- `\optoCoupler`, 11
- `\osr`, 56
- `\ote`, 56
- `\pcline`, 35
- `\potentiometer`, 8, 19, 20
- `\quadripole`, 11
- `\RelayNOP`, 6
- `\res`, 56
- `\resistor`, 4, 11, 17, 18
- `\resitor`, 13
- `\RFLine`, 4, 25
- `\Suppressor`, 6
- `\switch`, 5
- `\swpb`, 56
- `\swtog`, 56
- `\tension`, 12
- `\transformer`, 11, 13, 19
- `\transistor`, 7, 22
- `\Tswitch`, 8, 19
- `\Ucc`, 4
- `\wire`, 12
- `\xic`, 56
- `\xio`, 56
- `\Zener`, 5
- `\multidipole`, 11, 12, 16, 17, 35, 79
- multido, 3
- multiplier, 37
- N, 37
- nand, 46
- `\ncangle`, 6
- `\NewDiode`, 24
- `\NewLED`, 24
- `\NewSwitch`, 24
- `\newtransformer`, 11
- `\newtransformerquad`, 11
- `\NewZener`, 24
- nicpins, 56
- ninputs, 55
- nodesep, 8
- nor, 48
- not, 48
- `\OA`, 6, 20, 21
- OAminuslabel, 15
- OAinvert, 21
- OAioutlabel, 15
- OApluslabel, 15
- OAperfect, 21
- OApower, 7
- old, 35
- `\OpenDipol`, 13
- `\OpenTripol`, 13
- `\optoCoupler`, 11
- or, 47
- `\osr`, 56
- `\ote`, 56
- output, 36
- P, 22
- Package
 - multido, 3
 - pst-circ, 3, 4, 6, 52, 80
 - pst-node, 3
 - pst-xkey, 3
 - pstricks, 3
- parallel, 15, 16
- `\pcline`, 35
- plcaddress, 56
- plcsymbol, 56
- PNP, 7, 8
- `\potentiometer`, 8, 19, 20
- primarylabel, 13
- programmable, 37
- pst-circ, 3, 4, 6, 52, 80
- pst-circ.tex, 80
- pst-node, 3
- pst-xkey, 3
- pstricks, 3

- `\quadripole`, 11
- `quadripoleinput`, 41
- `quadrupole`, 15
- `Quartz`, 17

- `receptor`, 14
- `rectangle`, 18, 19
- `\RelayNOP`, 6
- `\res`, 56
- `reset`, 56
- `\resistor`, 4, 11, 17, 18
- `\resitor`, 13
- `\RFLine`, 4, 25
- `right`, 19, 36–41
- `RS`, 50

- `schottky`, 18
- `secondarylabel`, 13
- `set`, 56
- `\Suppressor`, 6
- `\switch`, 5
- `\swpb`, 56
- `\swtog`, 56
- Syntax
 - Collector, 8
 - Emitter, 8

- `\tension`, 12
- `tension`, 14
- `tensioncolor`, 14
- `tensionlabel`, 14
- `tensionlabelcolor`, 14
- `tensionlabeloffset`, 14
- `tensionoffset`, 14
- `tensionstyle`, 14
- `tensionwidth`, 14
- `three`, 35
- `thyristor`, 18
- `top`, 36, 39
- `\transformer`, 11, 13, 19
- `transformeriprimarylabel`, 15
- `transformerisecondarylabel`, 15
- `\transistor`, 7, 22
- `transistoribaslabel`, 15
- `transistoricollectorlabel`, 15
- `transistoriemitter`, 8

- `transistoriemitterlabel`, 15
- `transistorinvert`, 8
- `transistoritype`, 7, 8, 22
- `triac`, 18
- `triangle`, 35
- `tripole`, 6, 15
- `tripoleconfig`, 40
- `tripoleinput`, 40
- `tripolestyle`, 19, 20, 39, 40
- `TRot`, 7
- `\Tswitch`, 8, 19
- `two`, 35
- `twoCircles`, 17

- `\Ucc`, 4
- `unit`, 52
- `unlatch`, 56

- Value
 - :U, 13, 19, 20
 - and, 46
 - chemical, 17
 - crystal, 17
 - curved, 18
 - D, 51
 - elektor, 17–19
 - elektorchemical, 17
 - elektorcurved, 18
 - exnor, 50
 - exor, 49, 50
 - FET, 22
 - french, 20
 - generator, 14
 - GTO, 18
 - highpass, 37
 - JK, 51
 - left, 19
 - nand, 46
 - nor, 48
 - not, 48
 - or, 47
 - P, 22
 - PNP, 7, 8
 - rectangle, 18, 19
 - right, 19
 - RS, 50

schottky, 18
thyristor, 18
triac, 18
twoCircles, 17
varistor, 17
zigzag, 17, 19

value, 37
variable, 18, 19
varistor, 17

\wire, 12

\xic, 56
\xio, 56

\Zener, 5
zigzag, 17, 19